

Evolutionary conservation of drug actions:
from flies to humans

Dr. Giorgio Gilestro

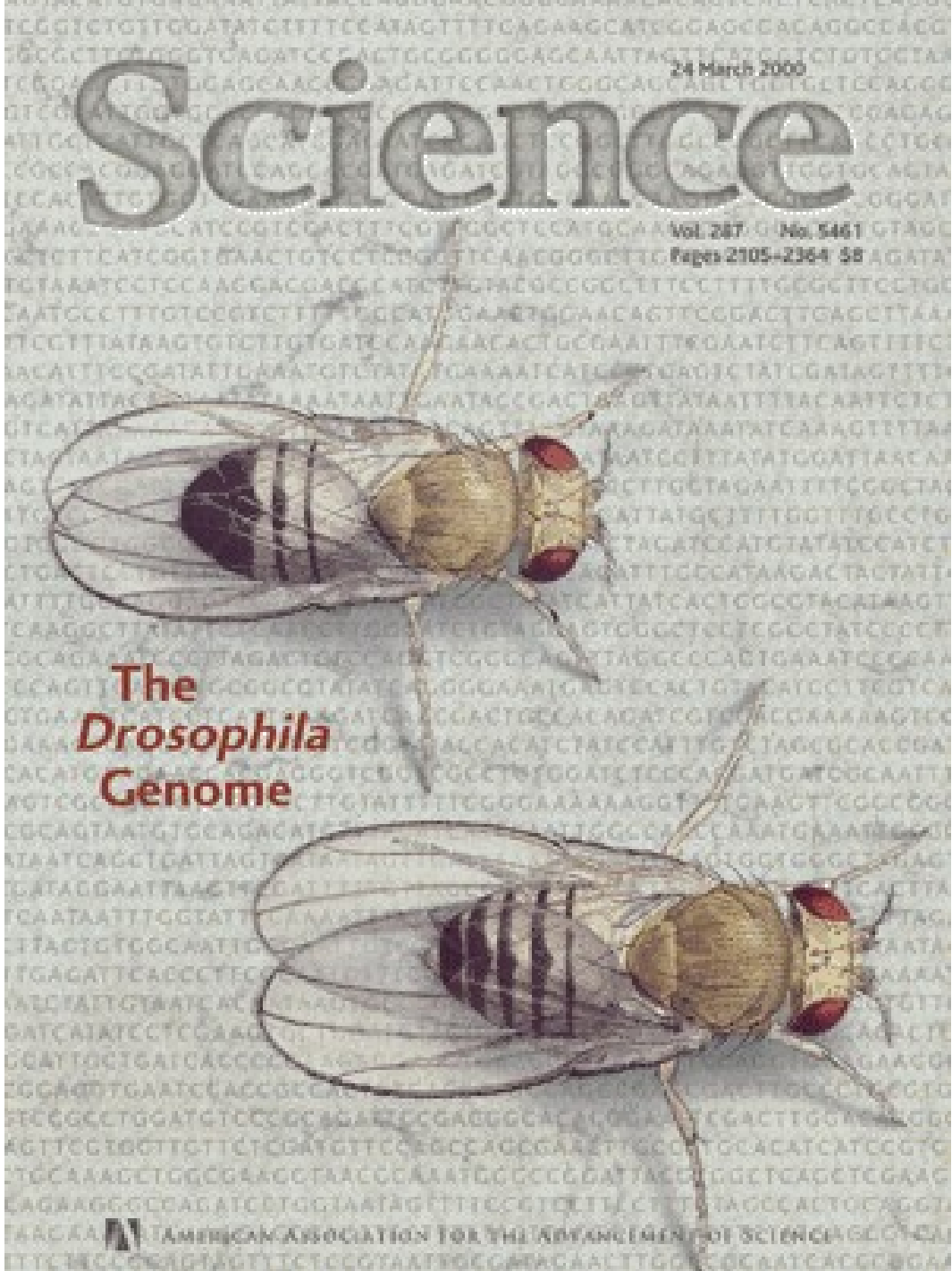

Science

24 March 2000

Vol. 287 No. 5461
Pages 2105-2364 \$8

The *Drosophila* Genome

Table 1. Classification of 714 Clear-Hit *Drosophila* Genes According to Human Disease Phenotypes

Disorder	No. of genes
Neurological	74
Neuromuscular	20
Neuropsychiatric	9
CNS/Developmental	8
CNS/Ataxia	9
Mental retardation	6
Other	22
Endocrine	50
Diabetes	10
Other	40
Deafness	13
Syndromic	7
Nonsyndromic	6
Cardiovascular	26
Cardiomyopathy	10
Conduction defects	4
Hypertension	7
Atherosclerosis	3
Vascular malformations	2
Ophthalmologic	43
Anterior segment	(13)
Aniridia	1
Rieger syndrome	1
Mesenchymal dysgenesis	2
Iridogoniodysgenesis	2
Corneal dystrophy	2
Cataract	3
Glaucoma	2
Retina	(30)
Retinal dystrophy	1
Choroiderimea	1
Color vision defects	4
Cone dystrophy	2
Cone rod dystrophy	1
Night blindness	8
Leber congenital amaurosis	2
Macular dystrophy	4
Retinitis pigmentosa	7

Pulmonary	4
Gastrointestinal	13
Renal	13
Immunological	33
Complement mediated	11
Other	22
Hematologic	42
Erythrocyte, general	29
Porphyrias	7
Platelets	6
Coagulation abnormalities	28
Malignancies	79
Brain	3
Breast	4
Colon	11
Other gastrointestinal	3
Genitourinary	5
Gynecologic	3
Endocrine	3
Dermatologic	3
Xeroderma pigmentosa	6
Other/sarcomas	9
Hematologic malignancies	29
Skeletal development	26
Craniosynostosis	5
Skeletal dysplasia	13
Other	8
Soft tissue	2
Connective tissue	18
Dermatologic	25
Metabolic/mitochondrial	123
Pharmacologic	12
Peroxisomal	9
Storage	37
Glycogen storage	11
Lipid storage	13
Mucopolysaccharidosis	10
Other	3
Pleitropic developmental	35
Growth, immune, cancer	7
Apoptosis	1
Other	27
Complex other	9
Total	714

Totals for categories of disease are in bold, subcategory totals are in parenthesis, and individual categories are in plain text.

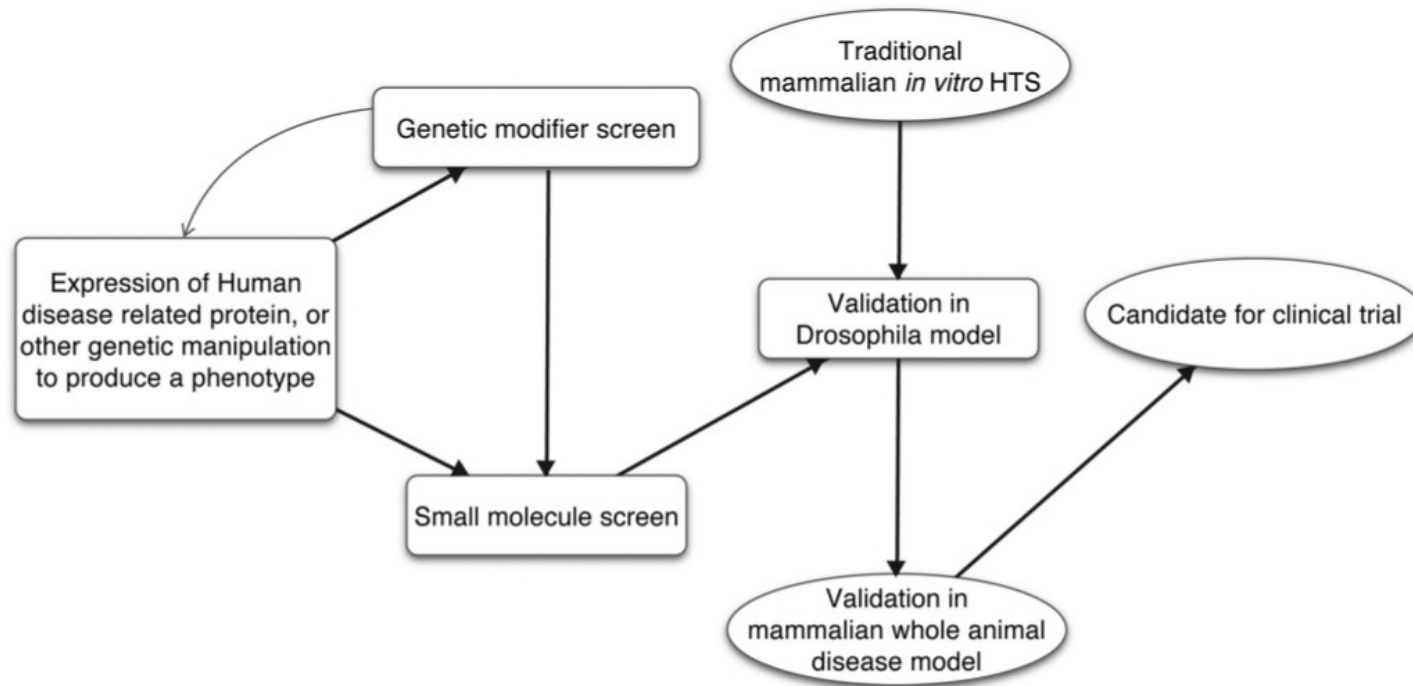
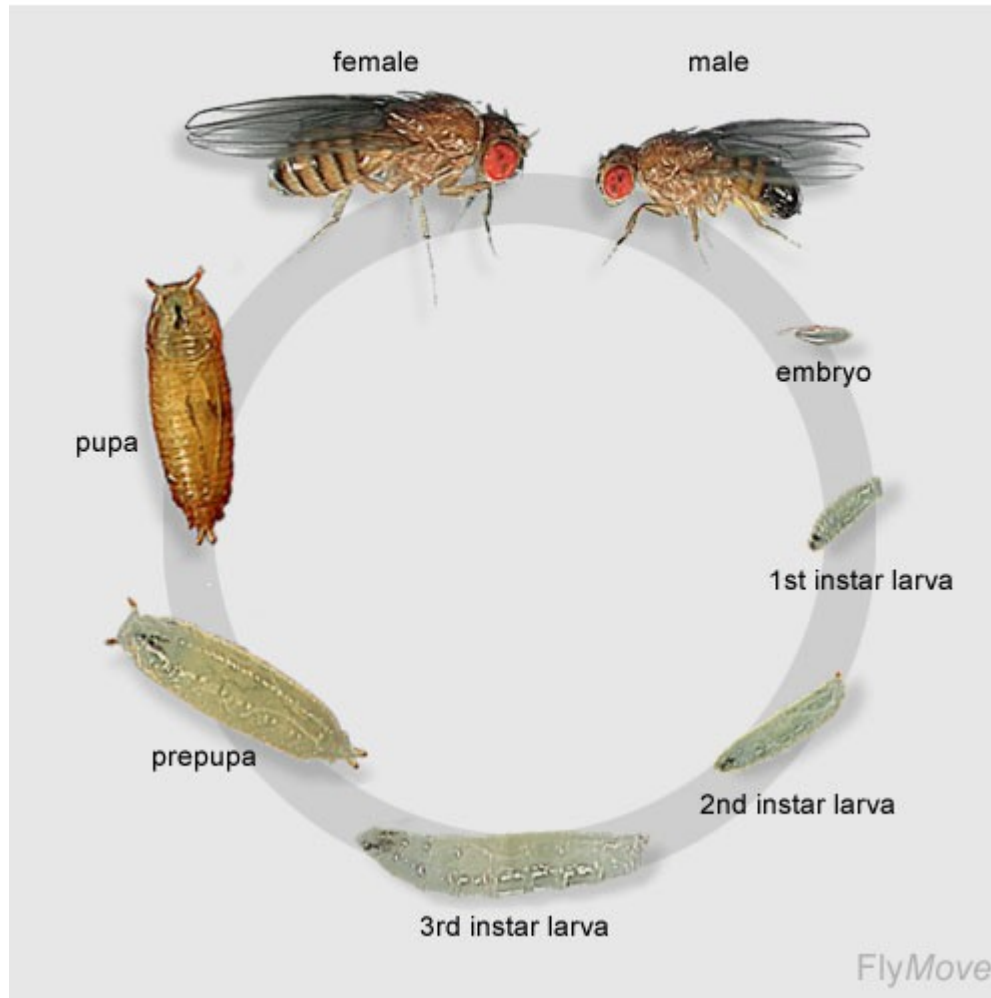

FIG. 1. *D. melanogaster* in the drug screening process. Models of human diseases are created in the fly by generation of mutants, either by mutation of the fly homolog of a human disease-related gene or by expression of the human form of the gene itself, that produce a scorable phenotype. This model can be directly screened for small molecules that rescue the phenotype or subject to genetic screens to identify modifiers of the phenotype, which represent new potential targets or models for the given disease. After initial screening, positive hits can be validated by testing in additional fly models of the disease. Significantly, these whole-animal validation studies can also be performed with the positive hits from traditional *in vitro* mammalian cell culture HTS to rapidly identify effective lead compounds. Drugs with efficacy in *D. melanogaster* models, however, will still need to be validated in mammalian whole-animal disease models.

The life cycle of *Drosophila melanogaster*



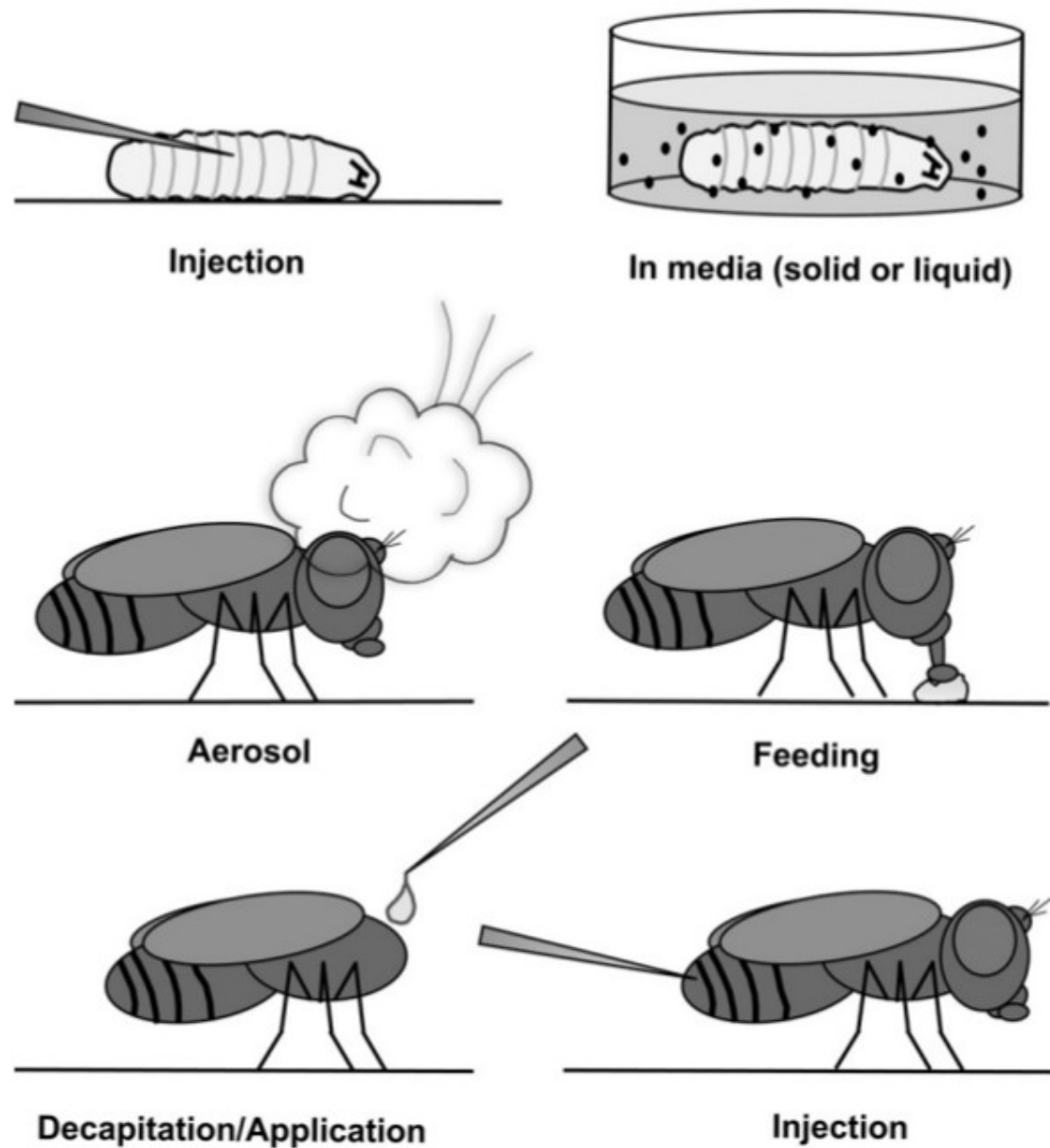

FIG. 2. Routes of drug administration. For larva (top), drug can be directly injected or drug can be mixed with media. Media can be either solid or liquid with 2% yeast paste to encourage feeding behavior. Adults can have drug delivered as an aerosol or gas, as a mixture with food substrate, as a direct application to exposed nerve cord, or as an injection. Drug administration through feeding generally has the highest throughput.

TABLE 1
Throughput in D. melangaster models

Stage	High Throughput	Medium Throughput	Low Throughput
Larvae	Lethality Body Size Necrotic Patches	Olfactory	Locomotor defect Body wall contraction Body wall muscle Response to pain
Adult	Lethality Flight ability Body size Stress test Anesthesia response	Body weight Sleep, arousal, and rest behavior Fecundity Aggression Wing expansion behavior	Life span Retinal degeneration Climbing assay Phototaxis Rotorod test Electrophysiology Prepulse inhibition Courtship behavior Feeding behavior Learning and memory behavior Response to pain Seizure behavior Visual discrimination

TABLE 3
Neurotransmitter-related behaviors

NT/Receptor	CNS-Related Behavior	Reference
Serotonin	Feeding, aggression, courtship, sleep, learning and memory	Dierick and Greenspan, 2007; Sitaraman et al., 2008; Alekseyenko et al., 2010; Neckameyer, 2010
5-HT _{1A-like}	Aggression, sleep, learning and memory	Yuan et al., 2005; Johnson et al., 2008, 2009
5-HT ₂	Circadian, aggression, visual processing	Nichols and Sanders-Bush, 2002; Nichols, 2007; Johnson et al., 2008
5-HT ₇	Learning and memory, courtship and mating	Johnson et al. 2010; C. D. Nichols, unpublished data
Dopamine	Locomotor activity, arousal, circadian	Foltényi et al., 2007; Hirsh et al., 2010
D1	Learning and memory, prepulse inhibition	Lebestky et al., 2009; Waddell, 2010
D2	Locomotor activity, arousal	Draper et al., 2007
Glutamate	Social interaction, learning and memory	Grosjean et al., 2008
GABA	Sleep, circadian, learning and memory	Chung et al., 2009; Hamasaka et al., 2005; Davis, 2005
Acetylcholine	Learning and memory, circadian	Gu and O'Dowd, 2006; Hamasaka et al., 2007

Genetic screenings

- From phenotype to genes (*forward genetics*)
- From genes to phenotypes (*reverse genetics*)
- From genes to genes through phenotypes (*modifier screen*)

Pharmacological screenings

- From drugs to phenotypes
- From drugs to phenotypes through genes (*target screen*)

- From phenotype to genes (forward genetics)

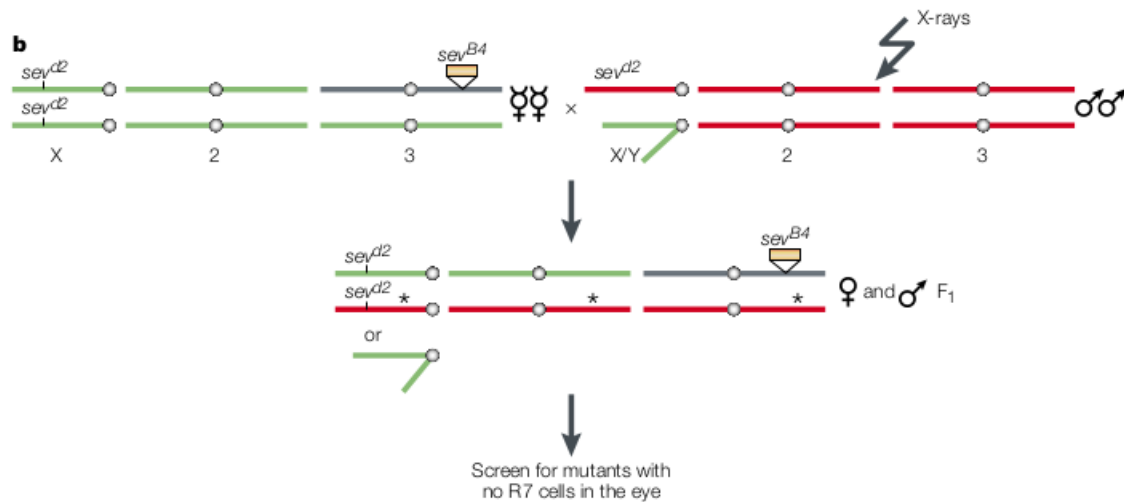
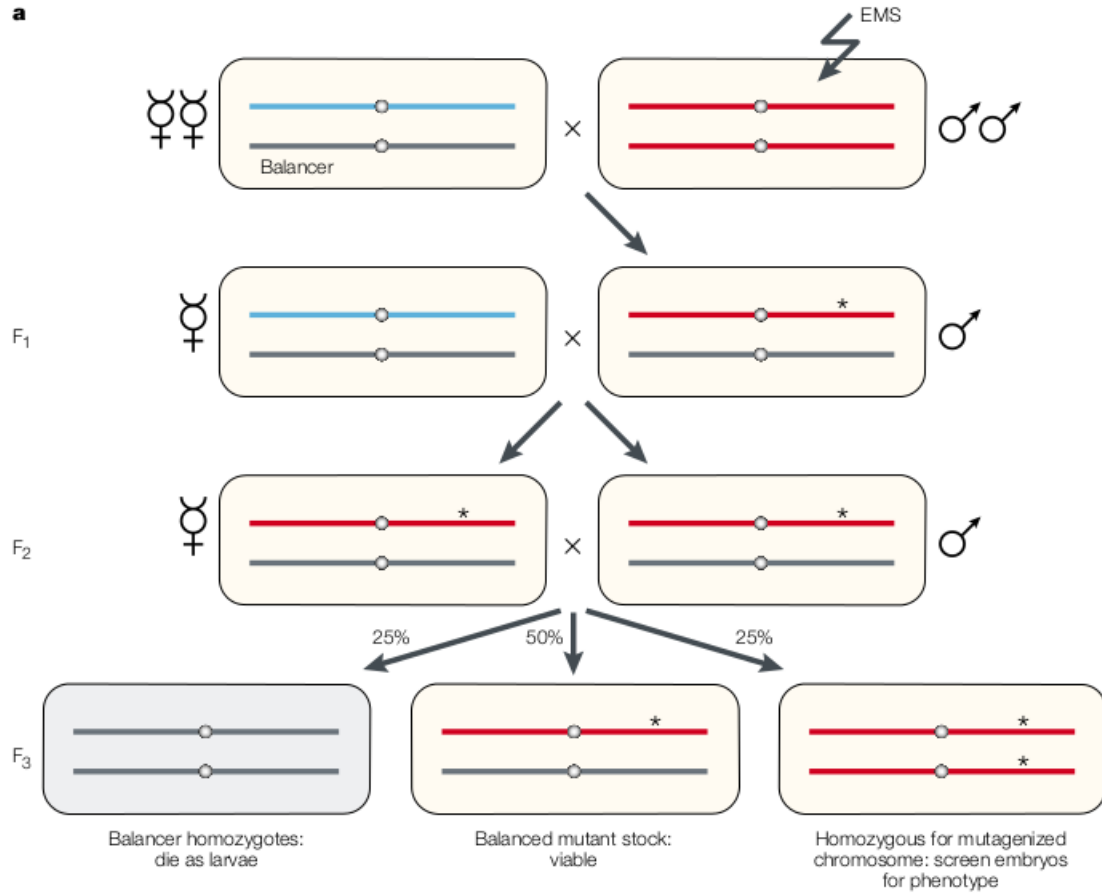

- From phenotype to genes (forward genetics)



Edward B. Lewis



Christiane Nüsslein-Volhard

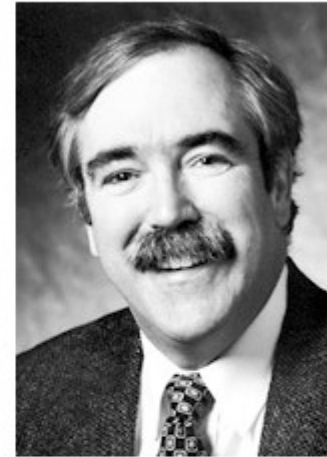

Eric F. Wieschaus

The Nobel Prize in Physiology or Medicine 1995 was awarded jointly to Edward B. Lewis, Christiane Nüsslein-Volhard and Eric F. Wieschaus "for their discoveries concerning the genetic control of early embryonic development".

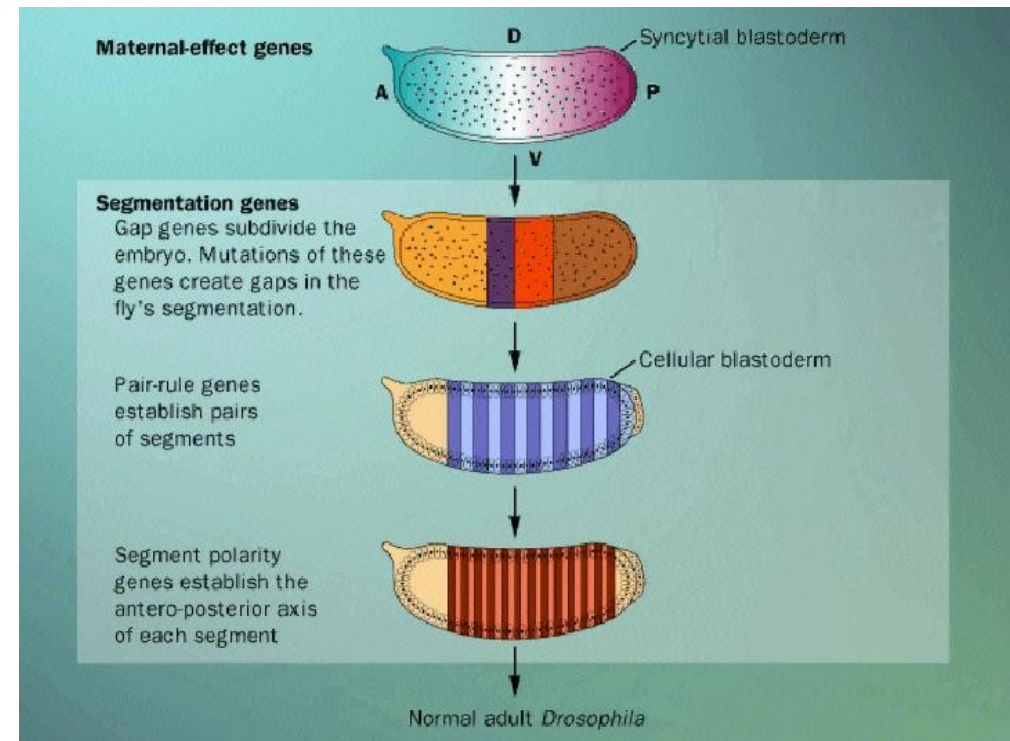
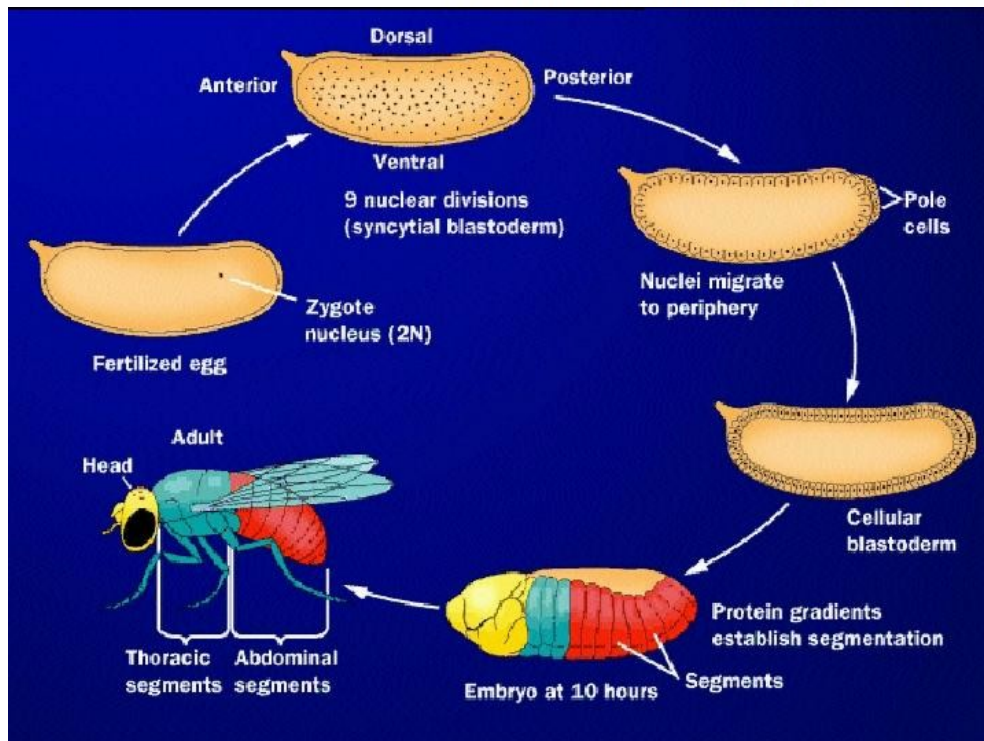

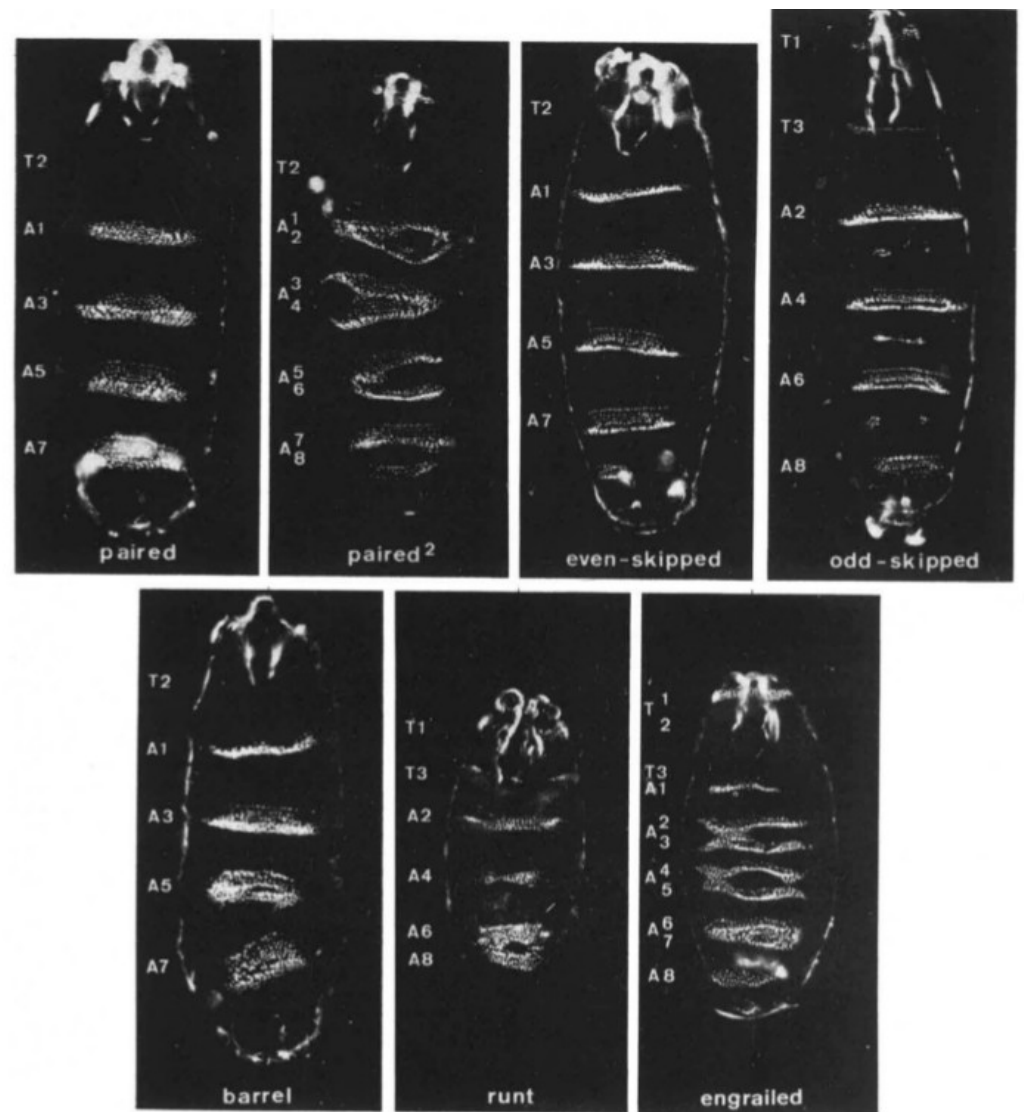
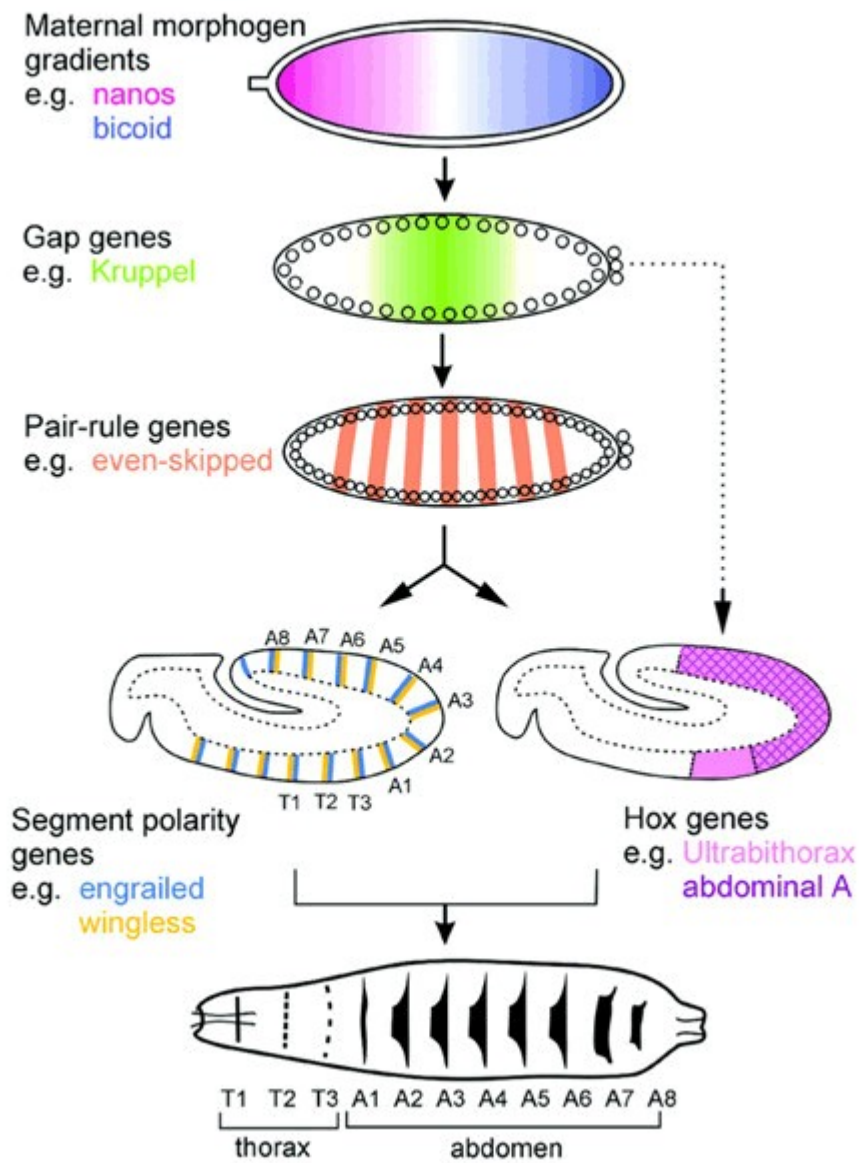

Fig. 4 Larvae homozygous for mutations at the six pair-rule loci. The segmental identity of the denticle bands is indicated at the left of each picture. A, abdominal band; T, thoracic band. For comparison with the normal pattern see Figs 1 and 2.

- From phenotype to genes (forward genetics)



Seymour Benzer in his office at Caltech in 1974 with a big model of *Drosophila*. He had a great deal of respect for an animal that not only can perform many sophisticated behaviours that humans do—such as learning, courting, and keeping time—but can also walk on the ceiling and fly.

Some Behavioral Mutants of *Drosophila*

Locomotor

sluggish
Hyperkinetic
flightless
uncoordinated
nonclimbing

Sexual

savoir-faire
fruity
stuck

Visual

nonphototactic
negative phototactic
nonoptomotor
negative optomotor

Response to stress

easily shocked
Shaker
freaked-out
paralyzed
parched

Nerve and muscle abnormality

photoreceptor
degeneration
lamina degeneration
wings-up
drop-dead

Circadian rhythm

arrhythmic
short-period
long-period

(From gene to behaviour. *Seymour Benzer*)

- Clever genetics

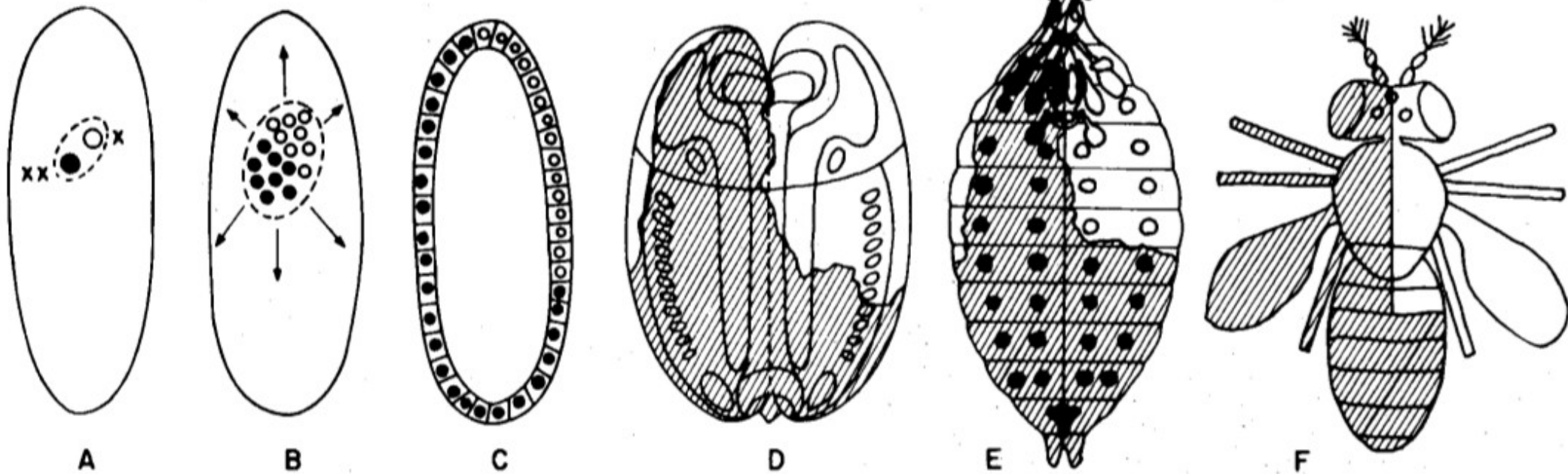

A mosaic fly may be formed by the loss of one X chromosome during the first nuclear division (A). The nuclei then migrate to the surface of the cell (B), and form a composite blastula (C). The fate map of the embryo (D) presages the map of larval structures destined to form the adult body parts (E), and the mosaic fly after metamorphosis (F).

- Clever behavioural analysis

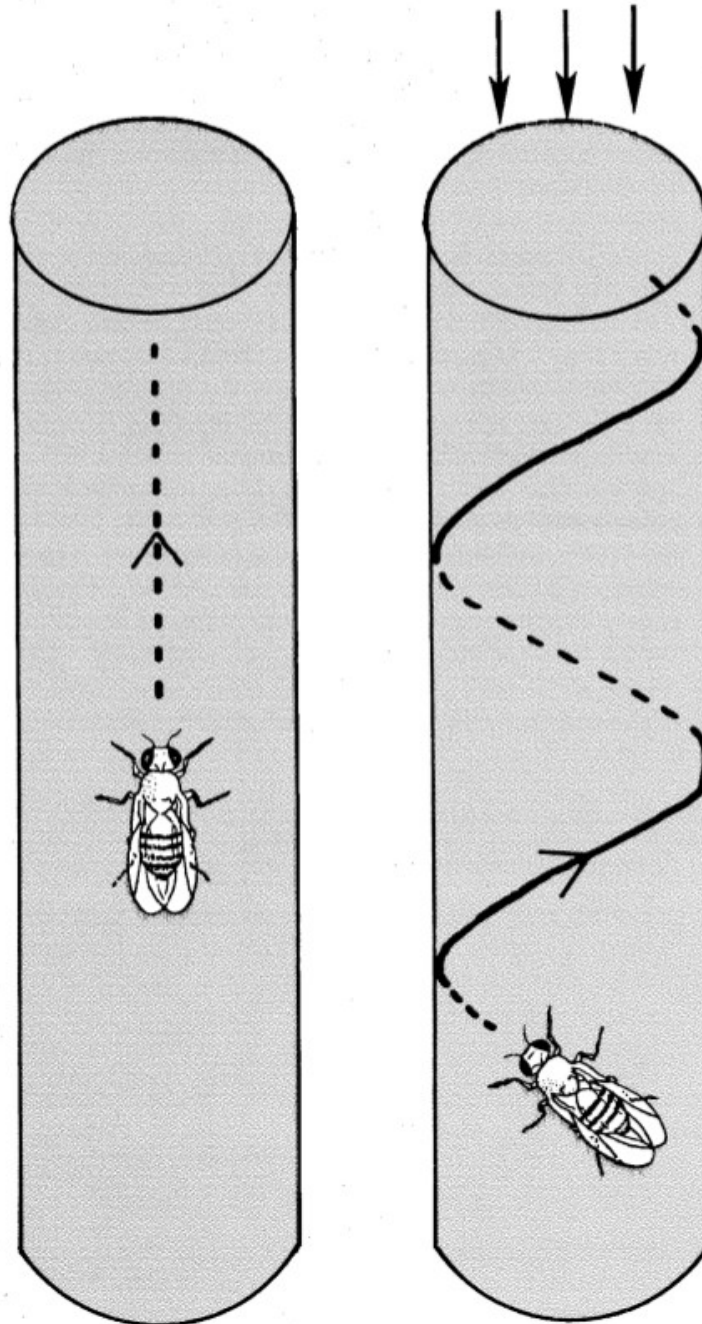

The climbing path of a mosaic fly with one blind eye—in darkness—is straight (left), but with a light shining from above the same fly will trace a helical path (right), turning the mutant eye toward the light in a futile attempt to balance input signals.

- Clever behavioural analysis

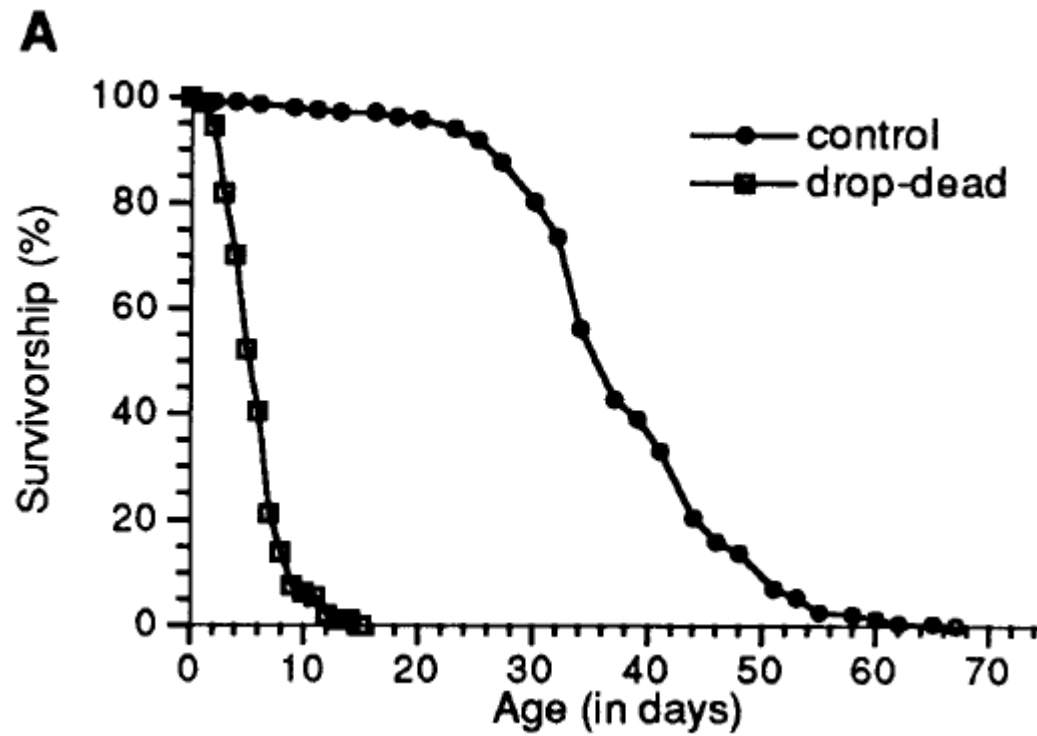

From phenotype to genes (forward genetics) Chimeric screenings

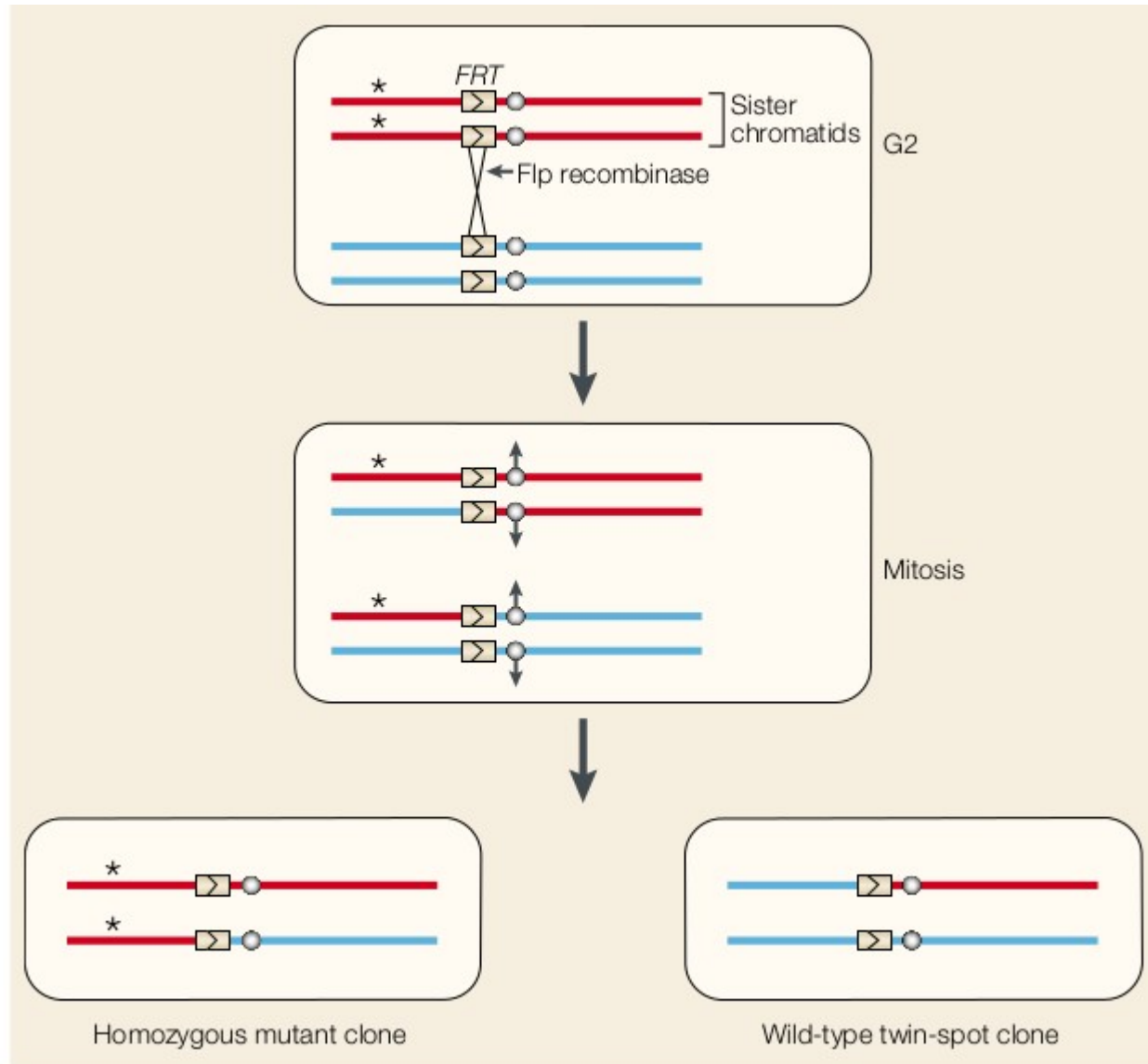

a Genotype: w eye-FLP; FRT P[w⁺] /FRT*

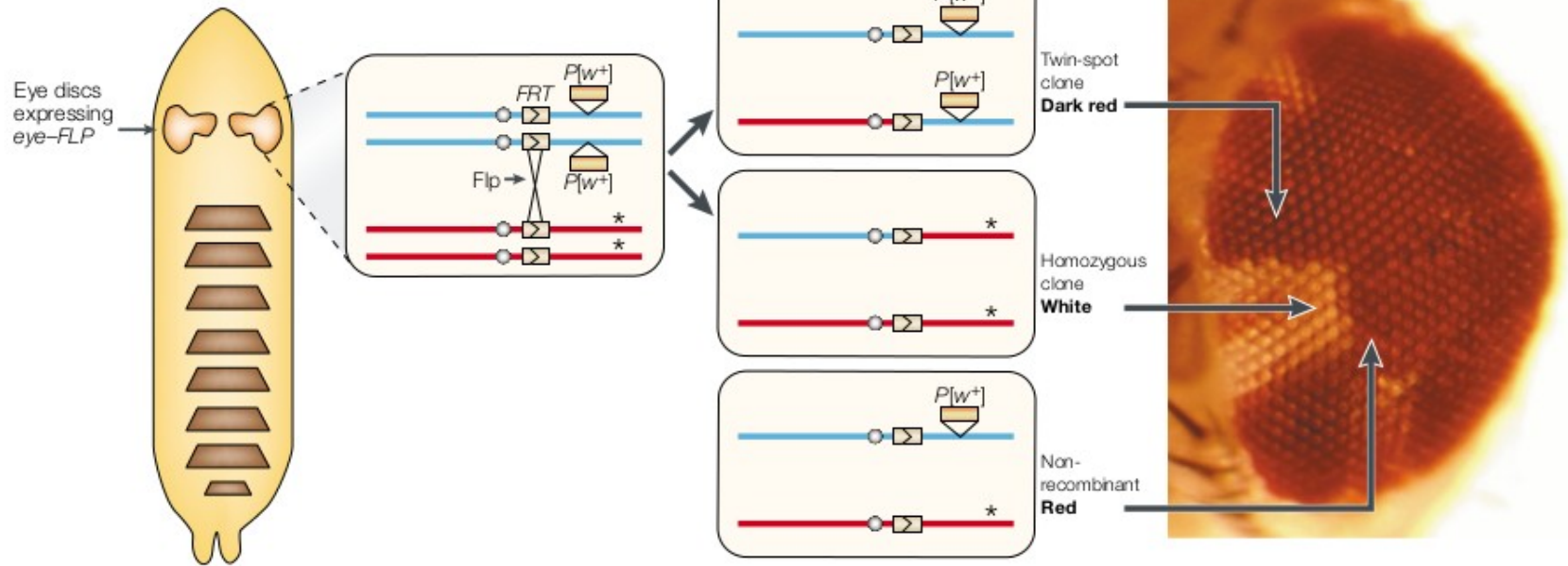

b Genotype: w eye-FLP; FRT P[w⁺] M /FRT*

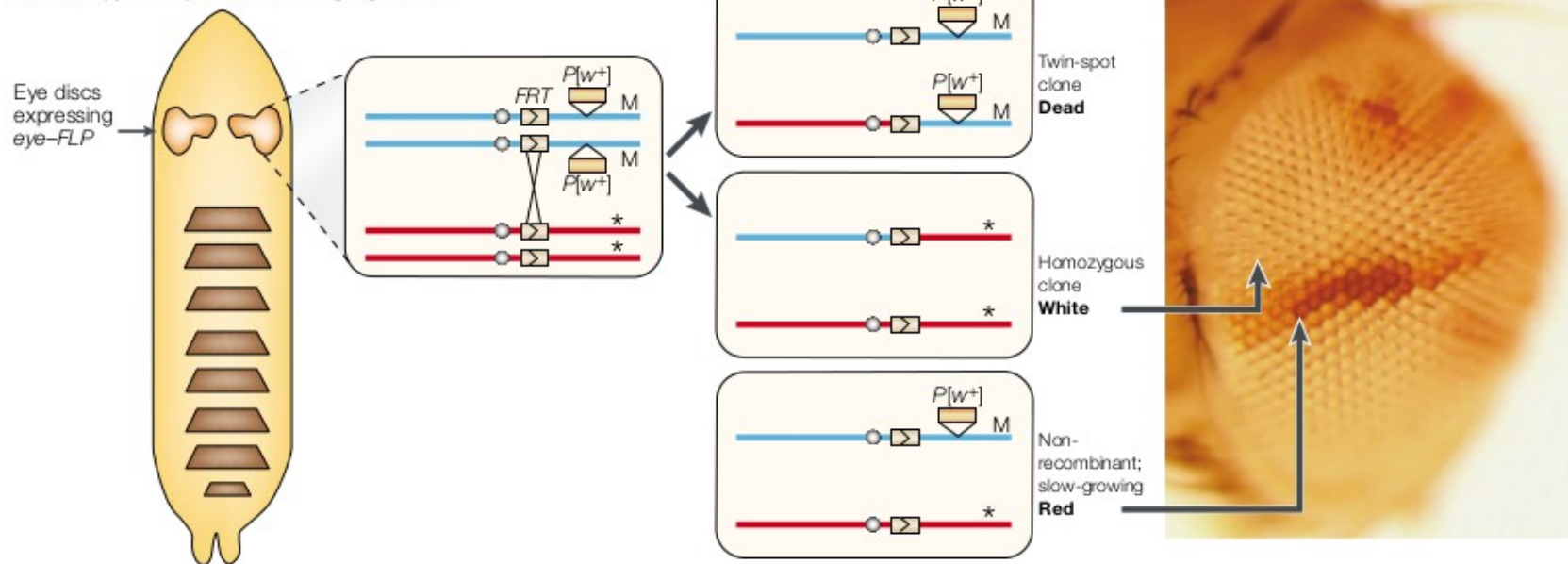

Figure 4 | **The eye-FLP technique for targeting clones to the eye.** By placing the *FLP* recombinase gene under the control of the *eyeless* enhancer (which drives expression specifically in the eye-antennal imaginal disc), Flp/FRT-mediated recombination can be targeted to this disc to generate homozygous mutant clones in the eye in flies that are otherwise heterozygous. **a** | The non-mutant chromosome (the asterisk indicates a mutation) is marked by a *mini-white* transgene, but there is no selection against the twin-spot clones or non-recombinant cells, and both the mutant clones (white) and the twin-spot clones (darker red, because they carry two copies of *white*⁺) are relatively small. **b** | The effects of incorporating a *Minute* mutation (*M*) onto the non-mutant *FRT* chromosome. The mutant clones now occupy almost all of the eye, because they outcompete the slow-growing non-recombinant cells (which are *M/+*), whereas the twin-spot clones die. (Photographs courtesy of Barry Dickson, Institute of Molecular Pathology, Vienna, and reproduced with permission from REF.69 © (2000) The Company of Biologists, Ltd.)

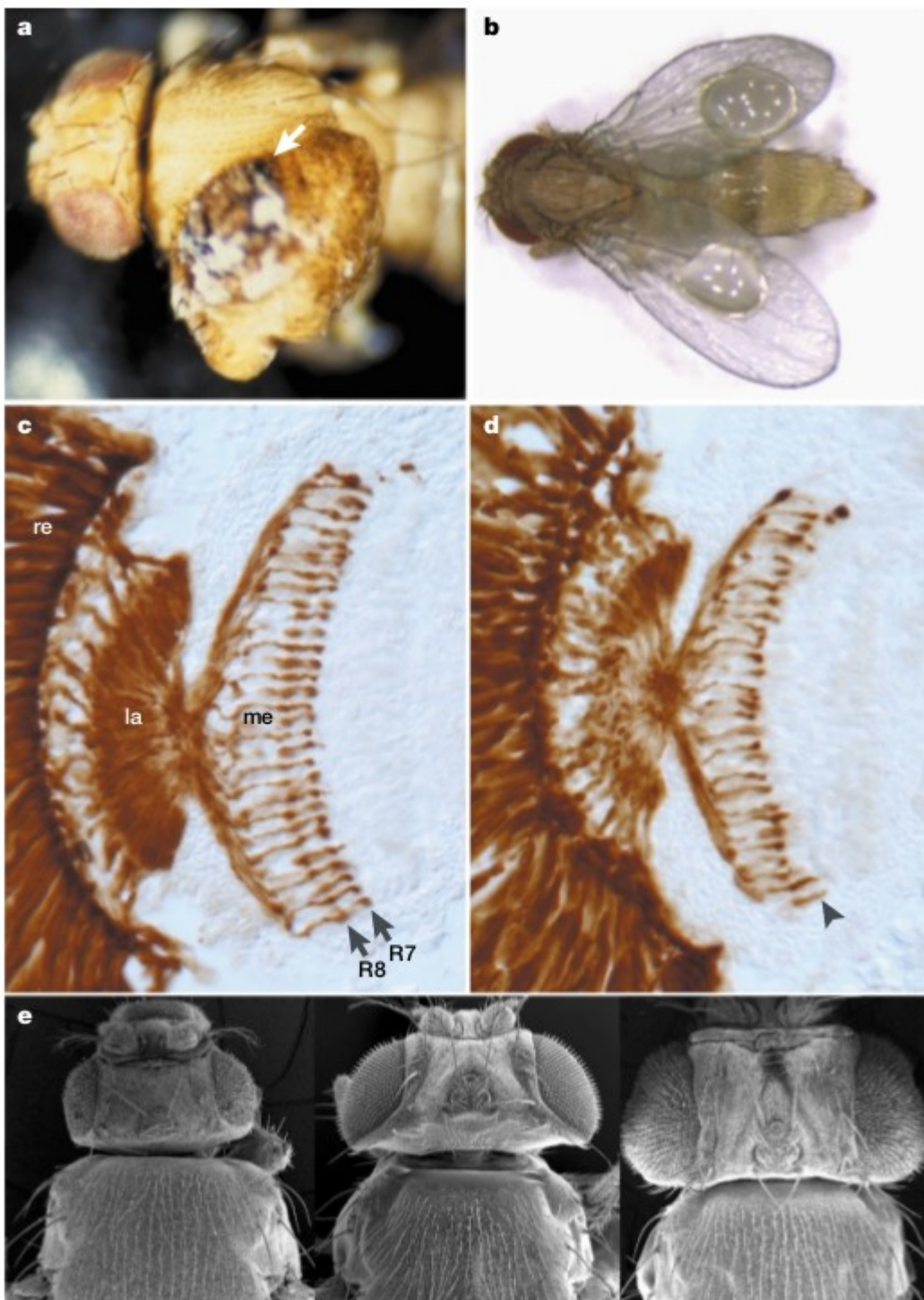

Figure 3 | **Examples of mutant phenotypes from Flp/FRT screens.** **a** | A NOTUM containing a homozygous *lats/warts* mutant clone, which has overgrown to form a large tumorous outgrowth (arrow). **b** | An adult fly with bubbles in both wings produced by clones of a mutant in *piopio* (*pio*), which disrupts adhesion between the dorsal and ventral surfaces of the wing. **c,d** | Section through an adult head showing the projections of retinal axons into the lamina (la) and medulla (me) of the optic lobe. 're' marks the position of the retina. **c** | Wild type. The R7 and R8 axons project to two distinct layers in the medulla. **d** | The R7 and R8 axons terminate in the same region of the medulla in *Leukocyte-antigen-related-like* (*Lar*) mutant clones, generated using *eye-FLP* with the *Minute* technique. In panels **a-d**, anterior is to the left. **e** | Scanning electron micrographs of the head and thorax of a wild-type fly (centre), and flies from the 'pinhead' screen with either a smaller (left) or larger (right) than normal head. (Panel **a** courtesy of Tain Xu, Yale University, USA, and reproduced with permission from REF. 50 © (1995) The Company of Biologists, Ltd; panel **b** courtesy of Nick Brown and Christian Boekel, Wellcome/CRC Institute, Cambridge, UK; panels **c, d** courtesy of Barry Dickson, Institute for Molecular Pathology, Vienna, and reproduced with permission from REF. 72 © (2001) Elsevier Science; panel **e** courtesy of Ernst Hafen, University of Zürich, Switzerland.)

From genes to phenotypes (*reverse genetics*)

RNAi and UAS/GAL4

Box 2 | The *GAL4-UAS* system for directed gene expression

The yeast transcriptional activator Gal4 can be used to regulate gene expression in *Drosophila* by inserting the upstream activating sequence (*UAS*) to which it binds next to a gene of interest (*gene X*)⁹⁶. The *GAL4* gene has been inserted at random positions in the *Drosophila* genome to generate 'enhancer-trap' lines that express *GAL4* under the control of nearby genomic enhancers, and there is now a large collection of lines that express *GAL4* in a huge variety of cell-type and tissue-specific patterns⁹⁷. Therefore, the expression of *gene X* can be driven in any of these patterns by crossing the appropriate *GAL4* enhancer-trap line to flies that carry the *UAS-gene X* transgene. This system has been adapted to carry out genetic screens for genes that give phenotypes when misexpressed in a particular tissue (modular misexpression screens)⁷⁹.

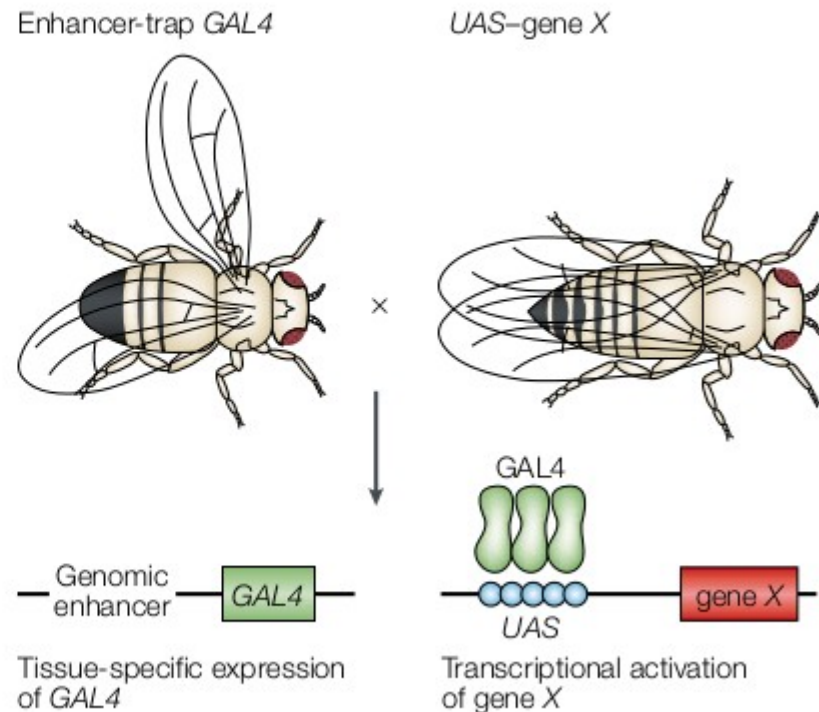

From genes to phenotypes (*reverse genetics*)

RNAi and UAS/GAL4

SABiosciences
A QIAGEN Company

www.SABiosciences.com
www.ProteinLounge.com

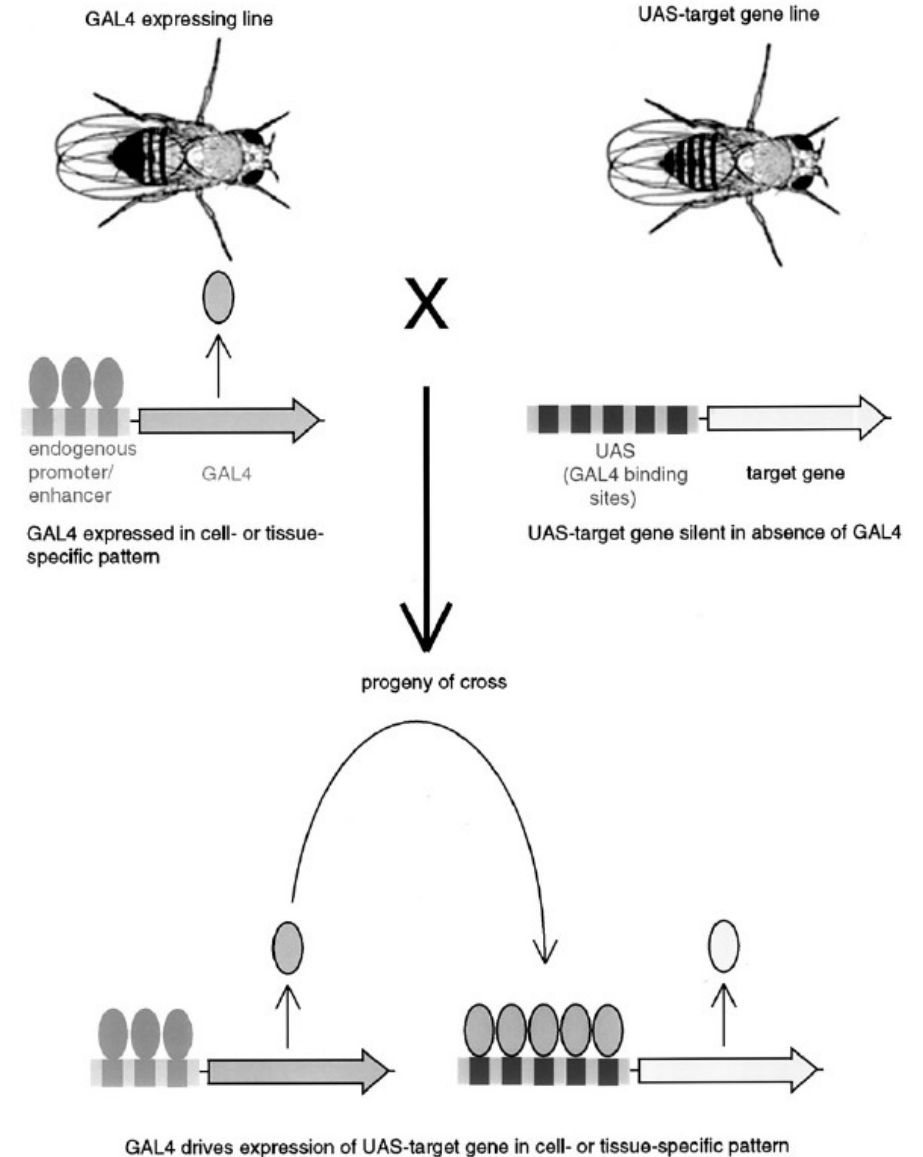
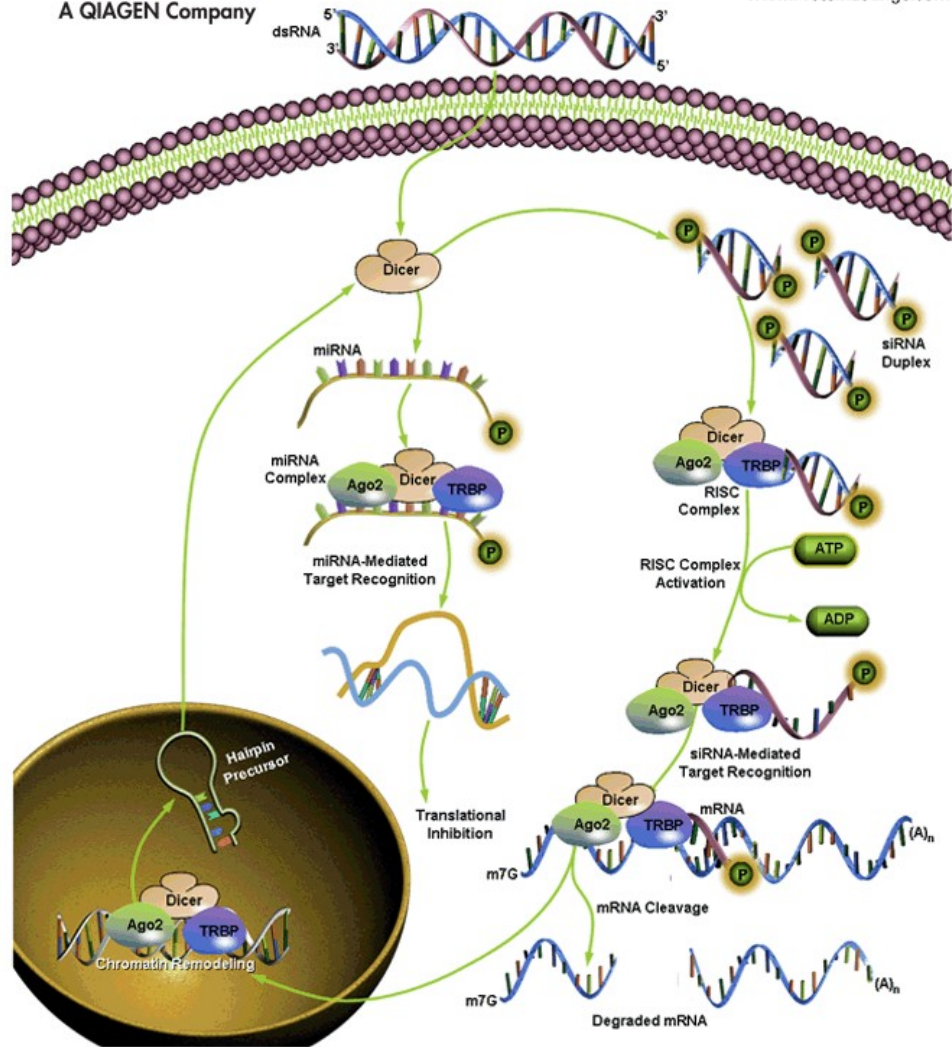
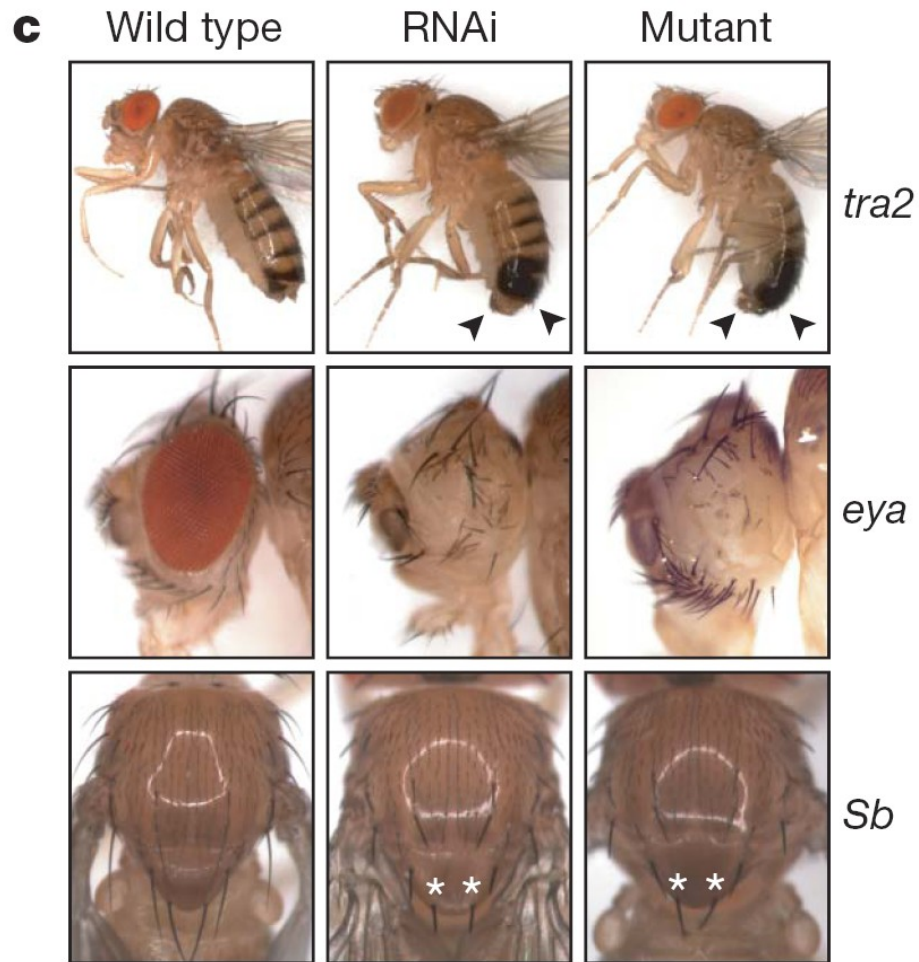

FIG. 1. GAL4 system.

Validation with obvious morphological phenotypes



Gene activity does not become null:
Hypomorphic effect

Transformer 2 (*tra2*) RNAi and mutant females anatomically resemble males, including male genitalia and abdominal pigmentation.

The eyes are greatly reduced or absent in eyes absent (*eya*) RNAi and mutant males.

Stubble (*Sb*) males have short, stubby bristles on the notum.

Phenotypes screened using RNAi

Muscle formation and development (flying muscles)

Pain (from larvae to mice)

Heart development and failure

Bristle formation (asymmetric cell division)

Obesity

Immune response

Sugar vs protein food preference

Neuronal control of *Drosophila* courtship

Bristle formation (asymmetric cell division)

a

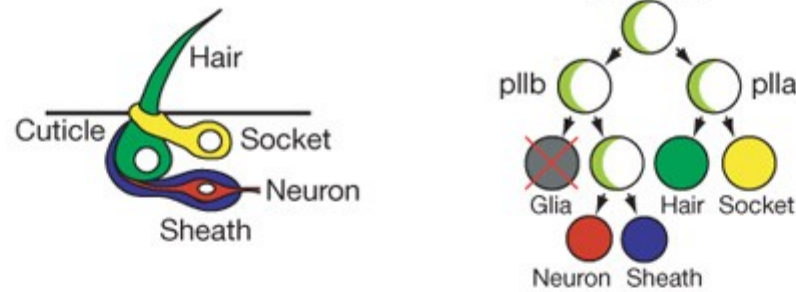

b

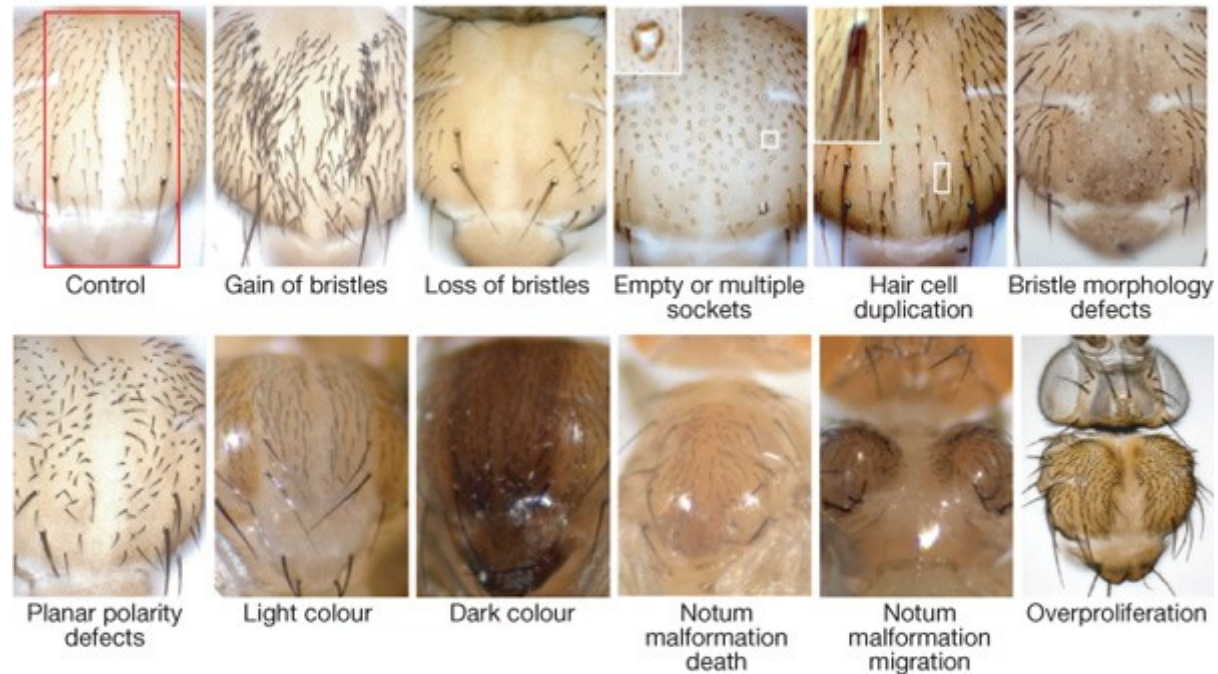

c

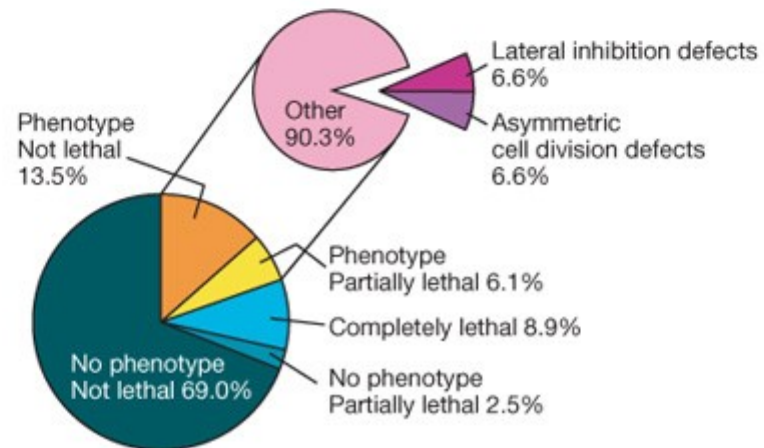

Obesity

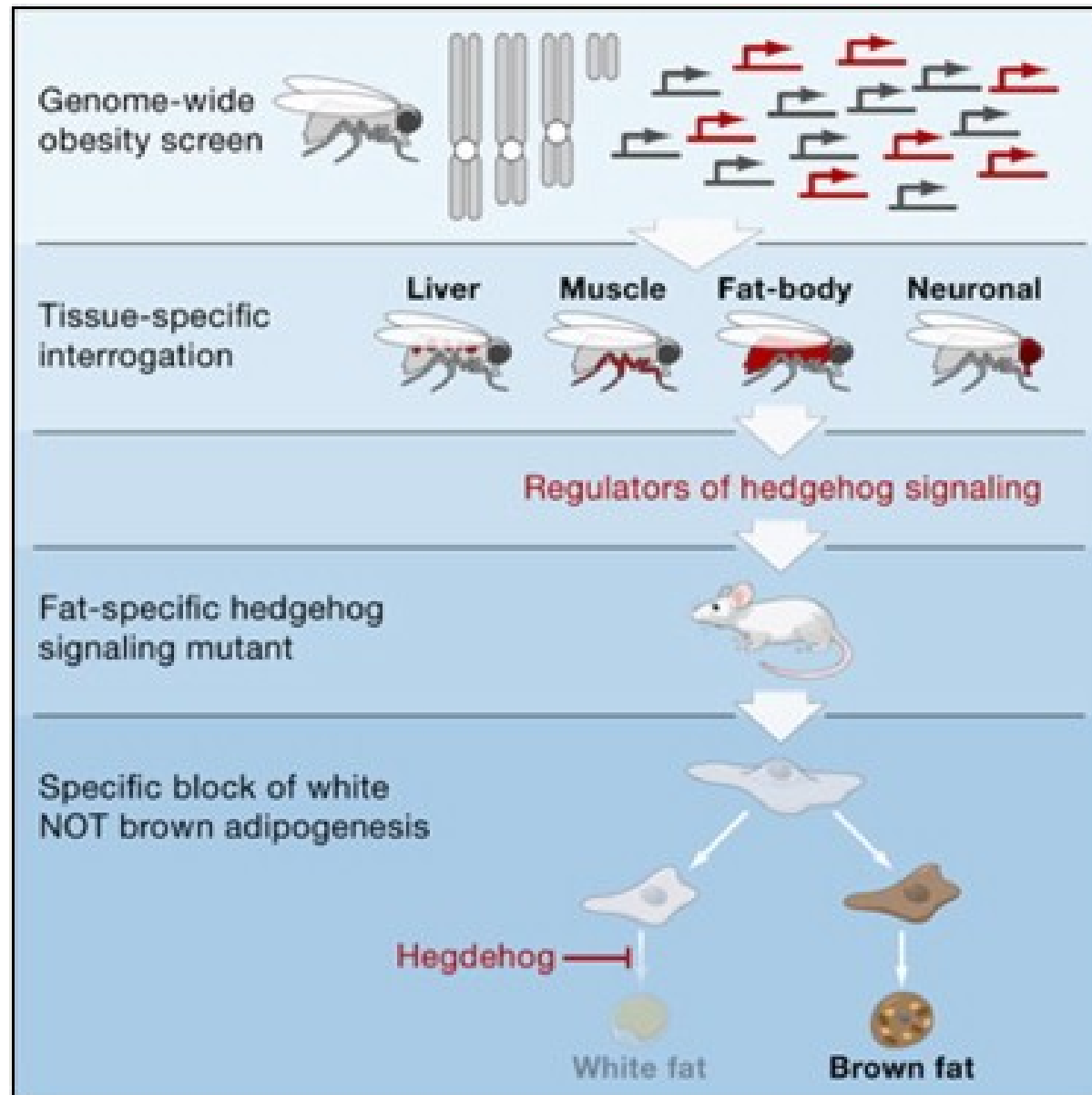

Heart development and failure

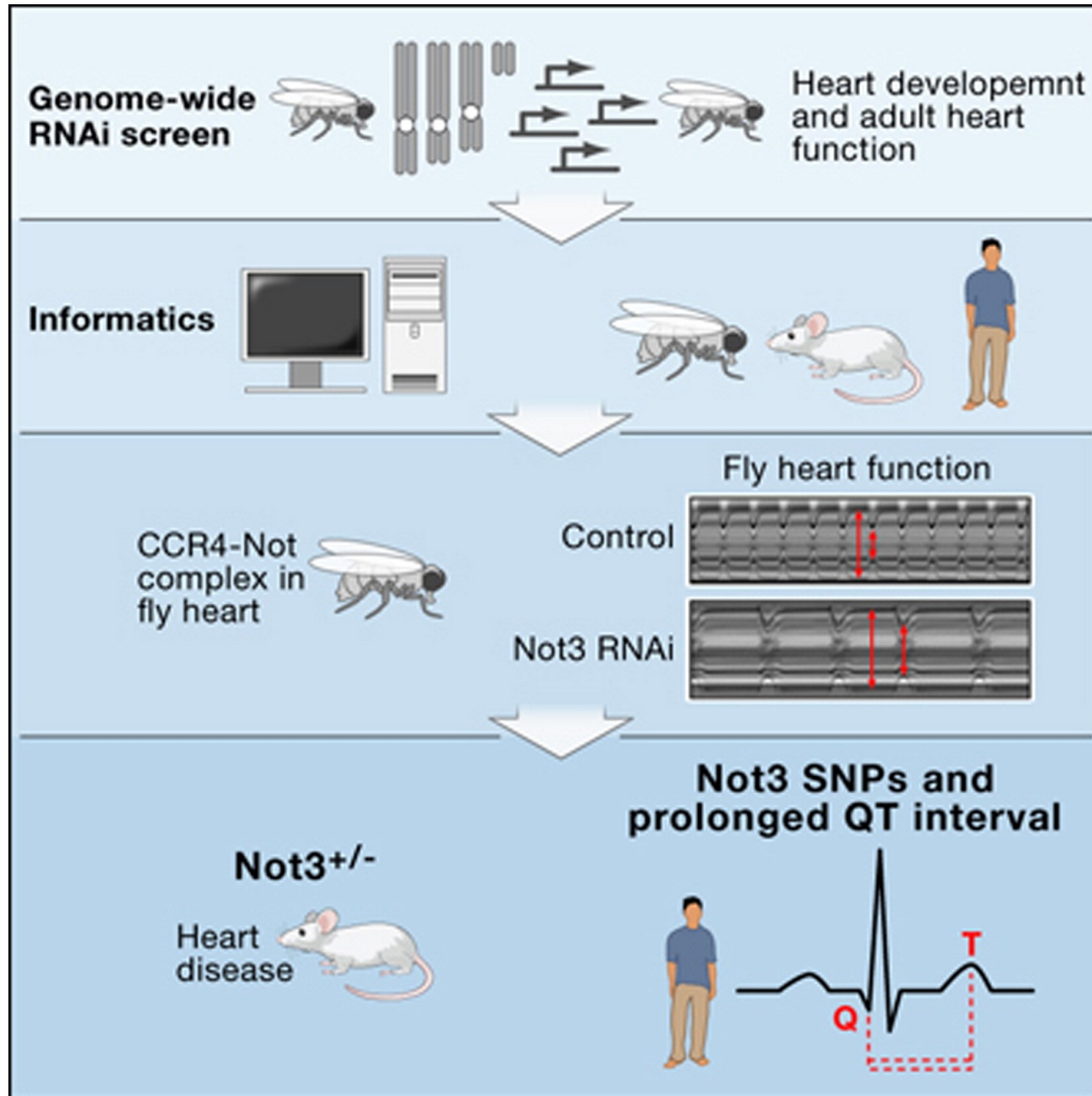

Obesity

Genome-wide RNAi screen for avoidance of noxious heat in *Drosophila*

Pinpoints Ca^{2+} channel subunit $\alpha 2\text{-}\delta$ as a candidate nociception gene

A2 δ 3 is a pain gene in *Drosophila*, mice and humans

In mice, loss of $\alpha 2\delta 3$ results in sensory cross-activation in response to heat pain and touch

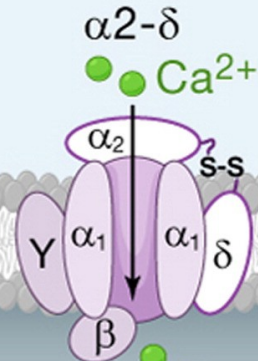

Wild-type

HEAT

Activation of
"pain"
centers

A2 δ 3 KO

HEAT

Activation of
visual, auditory
and olfactory
centers

Sugar vs protein food preference



Neuronal control of *Drosophila* courtship

a Orienting

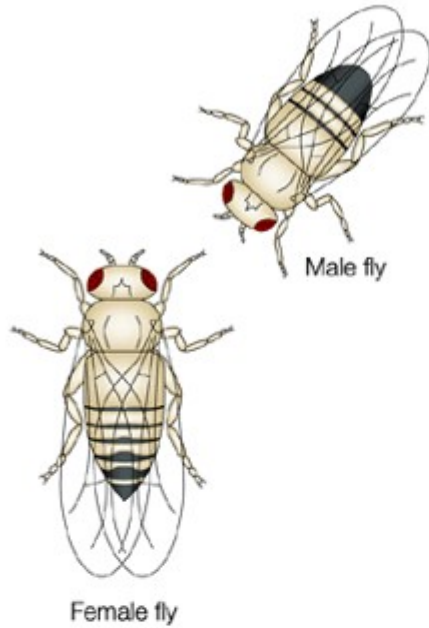

b Tapping

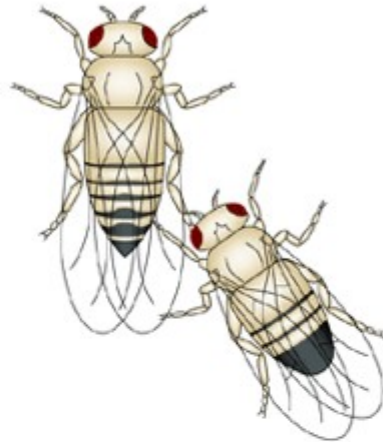

c 'Singing'

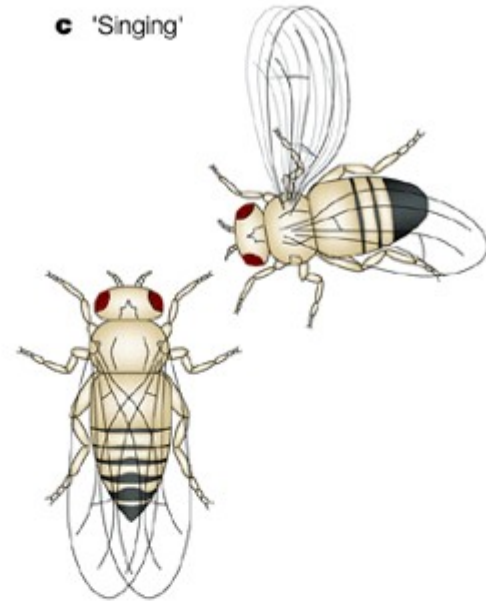

d Licking

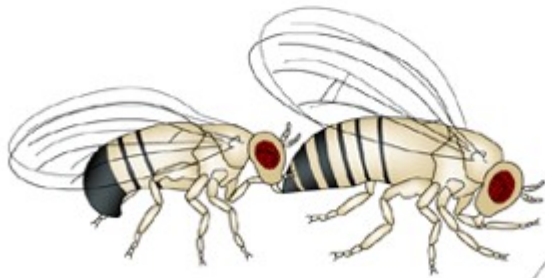

e Attempting copulation

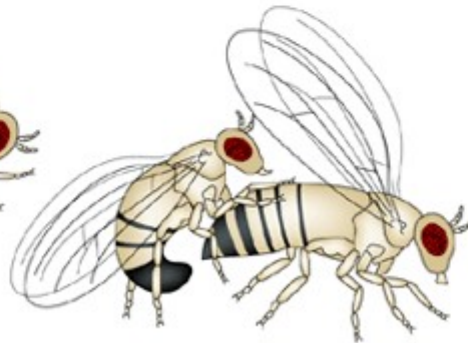

f Copulation



- From genes to genes through phenotypes (*modifier screen*)

Cell, Vol. 64, 39–48, January 11, 1991, Copyright © 1991 by Cell Press

Genetic Dissection of a Neurodevelopmental Pathway: *Son of sevenless* Functions Downstream of the *sevenless* and EGF Receptor Tyrosine Kinases

Ronald D. Rogge,* Chris A. Karlovich,*
and Utpal Banerjee*†

* Department of Biology
† and Molecular Biology Institute
University of California
Los Angeles, California 90024

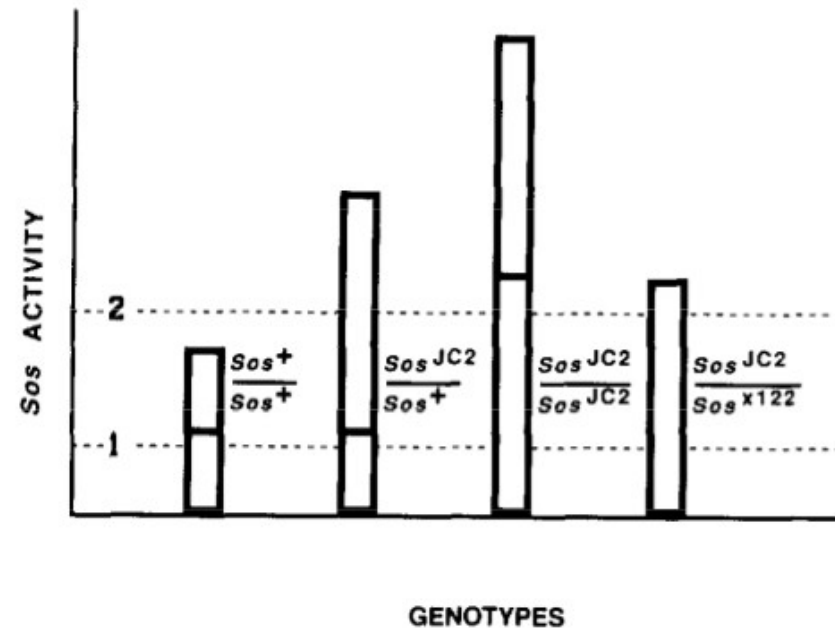

Figure 5. A Model of the Sos^{JC2} Suppression

The vertical bars represent the amount of *Sos* activity found in the various genotypes. The horizontal line numbered 1 represents the amount of *Sos* activity required for R7 development in wild-type flies. The horizontal line numbered 2 represents the increased amount of *Sos* activity needed in sev^{E4} flies for any R7 development to occur. In such flies, higher levels of *Sos* activity allow a greater number of R7 cells to develop.

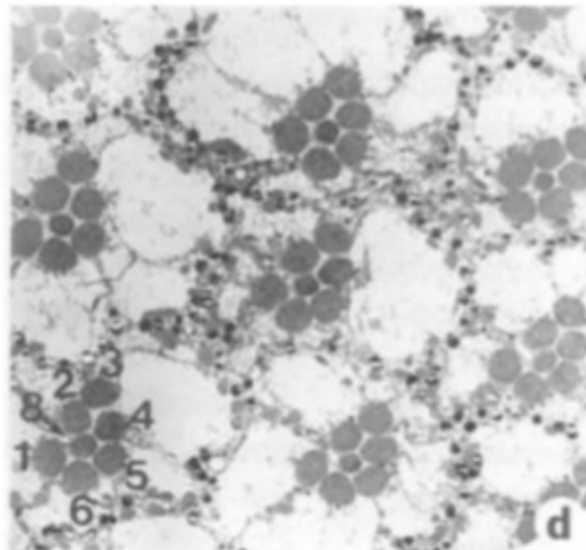
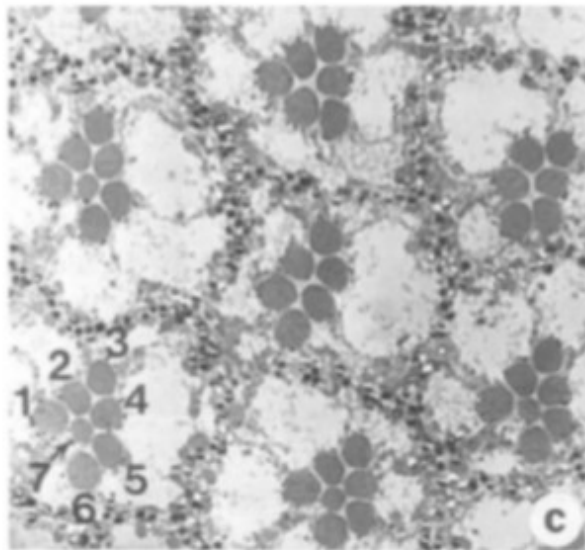
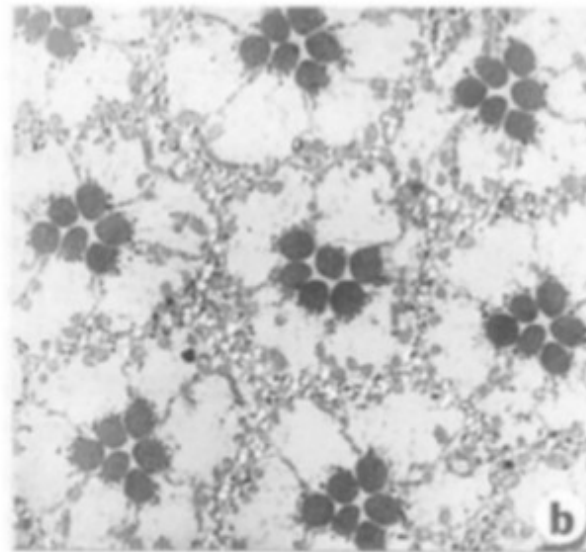
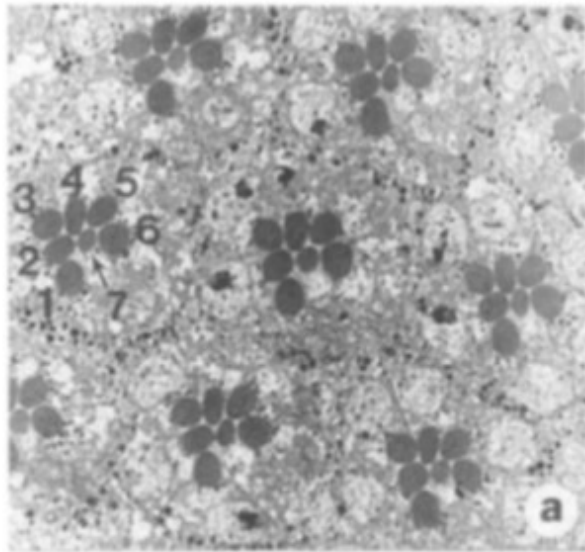

Figure 1. Transmission Electron Micrographs of Adult Eyes

(a) A distal section through a wild-type eye. The dark structures are rhabdomeres of the photoreceptor (R) cells. At this level of section, rhabdomeres of R1–R6 cells surround the central R7 rhabdomere, which projects between R1 and R6. The rhabdomere of R8 is proximal to R7 and is therefore not in this section.

(b) A distal section through a *sev^{E4}* eye. In this mutant R7 is missing in every ommatidium of the eye.

(c) A distal section through a *sev^{E4}; Sos^{JC2}* eye. In this double mutant, a fraction of the ommatidia contain an R7 cell.

(d) A proximal section of a *sev^{E4}; Sos^{JC2}* eye. At this level, the central cell is R8. This cell projects between R1 and R2. Occasionally in ommatidia lacking R7, the R8 cell projects its rhabdomere between R1 and R6 rather than R1 and R2.

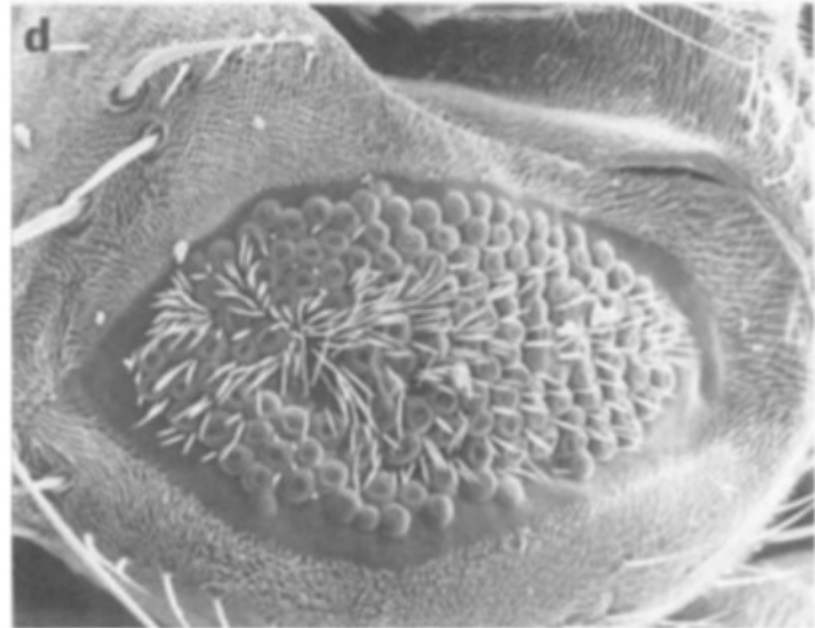
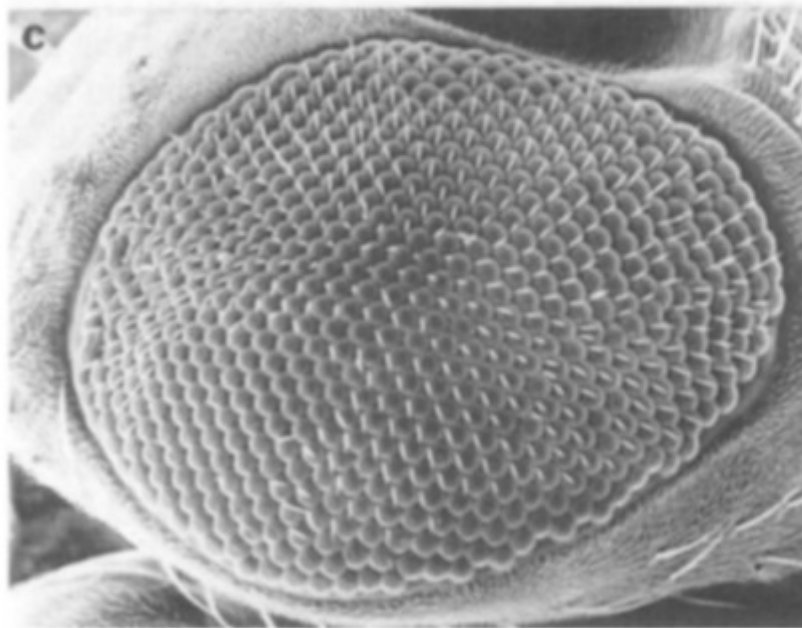
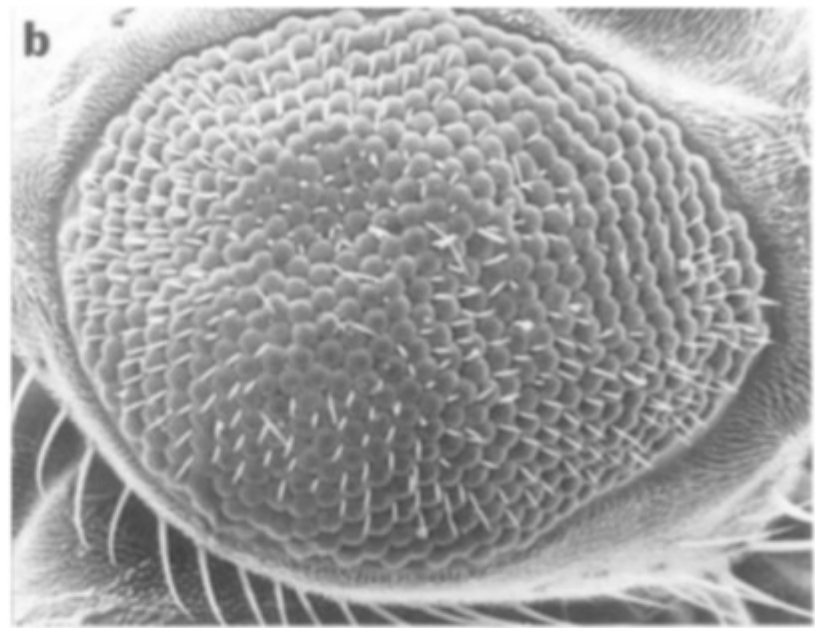
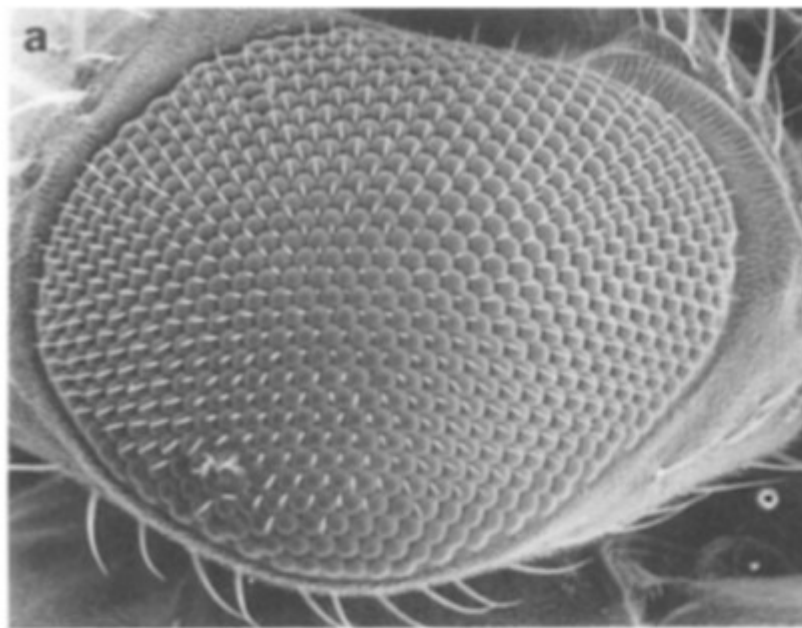

Figure 4. Interaction between *Sos* Alleles and the *Eip* Mutation

(a) Scanning electron micrograph (SEM) of a wild-type eye.

(b) SEM of an *Eip* eye. The eye is disorganized and rough.

(c) SEM of *Sos^{dm7}/Eip* double mutant eye. The *Eip* eye phenotype is suppressed.

(d) SEM of *Sos^{JC2}/Eip* double mutant eye. The *Eip* eye phenotype is greatly enhanced.

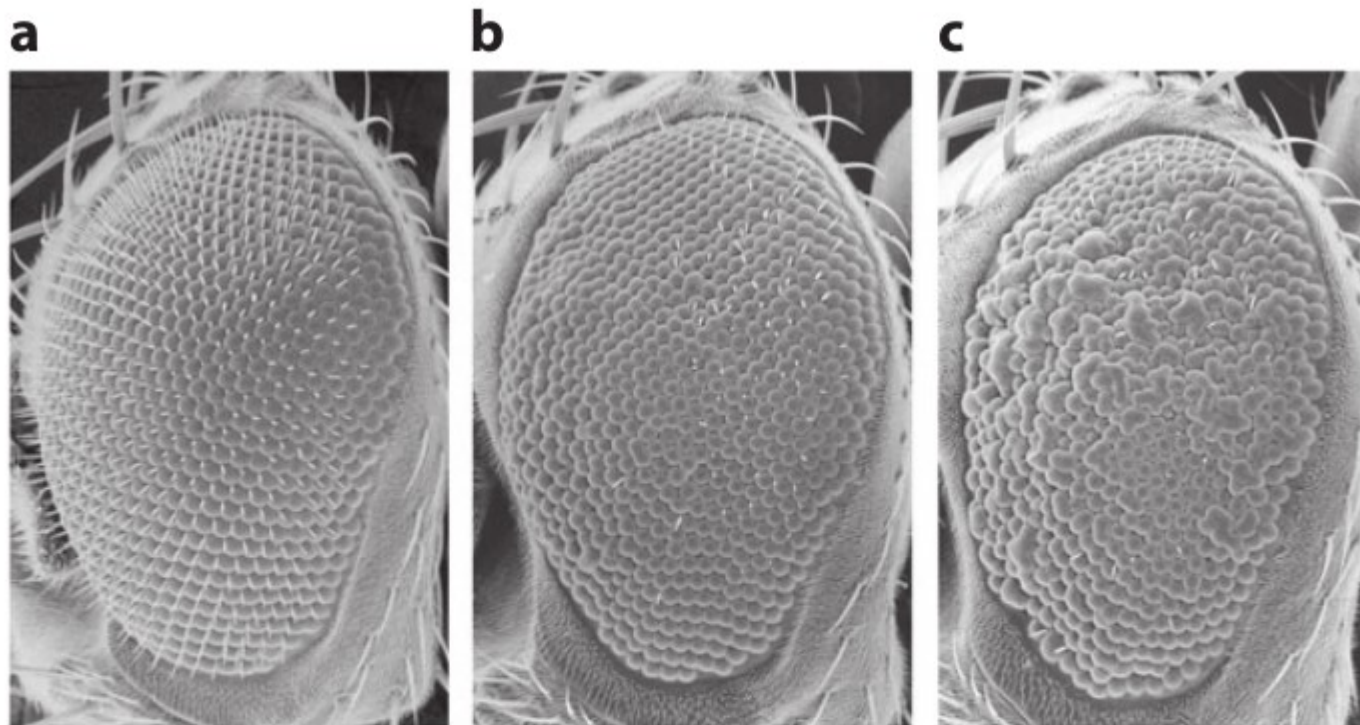

Figure 1

Scanning electron microscopy images of a fly eye, showing genetic interaction between amyloid precursor protein (APP) and tau. (a) Overexpression of APP in the fly eye has little effect on eye morphology, as shown by the smooth appearance of the eye surface. (b) Overexpression of tau causes mild loss of photoreceptors and a slight roughness of the eye surface. (c) Co-overexpression of APP and tau strongly enhances the rough-eye phenotype. Modified from Wang et al. (58).

• From drugs to phenotypes

The Journal of Neuroscience, December 1, 2004 • 24(48):10993–10998 • 10993

Brief Communication

Chronic Exposure to Rotenone Models Sporadic Parkinson's Disease in *Drosophila melanogaster*

Hélène Coulom and Serge Birman

Laboratoire de Génétique et Physiologie du Développement, Centre National de la Recherche Scientifique, Université de la Méditerranée, Developmental Biology Institute of Marseille, Campus de Luminy, F-13288 Marseille Cedex 9, France

Parkinson's disease (PD) is a movement disorder characterized by the selective degeneration of nigrostriatal dopaminergic neurons. Both familial and sporadic cases present tremor, rigidity, slowness of movement, and postural instability. Although major insights into the genes responsible for some rare hereditary cases have arisen, the etiology of sporadic cases remains unknown. Epidemiological studies have suggested an association with environmental toxins, mainly mitochondrial complex I inhibitors such as the widely used pesticide rotenone. In recent years, *Drosophila melanogaster* has been used as a model of several neurodegenerative diseases, including a genetic model of PD. Here, we studied the neurodegenerative and behavioral effects of a sublethal chronic exposure to rotenone in *Drosophila*. After several days, the treated flies presented characteristic locomotor impairments that increased with the dose of rotenone. Immunocytochemistry analysis demonstrated a dramatic and selective loss of dopaminergic neurons in all of the brain clusters. The addition of L-dopa (3,4-dihydroxy-L-phenylalanine) into the feeding medium rescued the behavioral deficits but not neuronal death, as is the case in human PD patients. In contrast, the antioxidant melatonin (*N*-acetyl-5-methoxytryptamine) alleviated both symptomatic impairment and neuronal loss, supporting the idea that this agent may be beneficial in the treatment of PD. Therefore, chronic exposure to pesticides recapitulates key aspects of PD in *Drosophila* and provides a new *in vivo* model for studying the mechanisms of dopaminergic neurodegeneration.

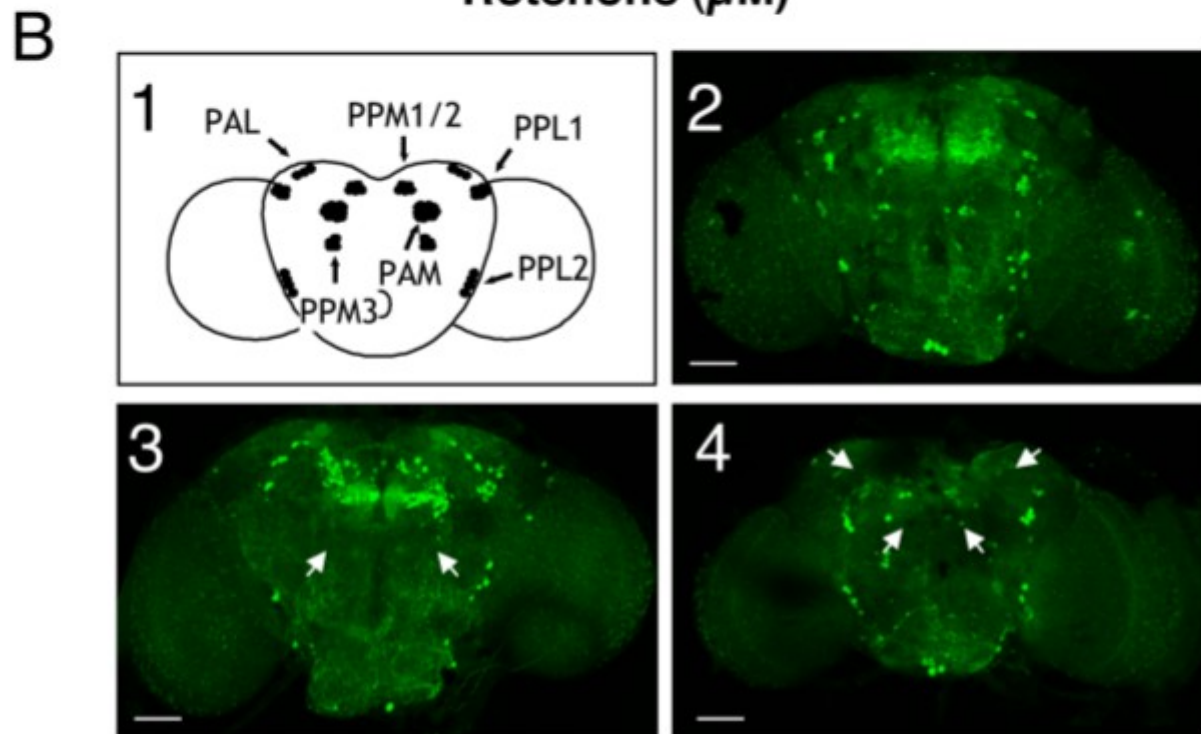
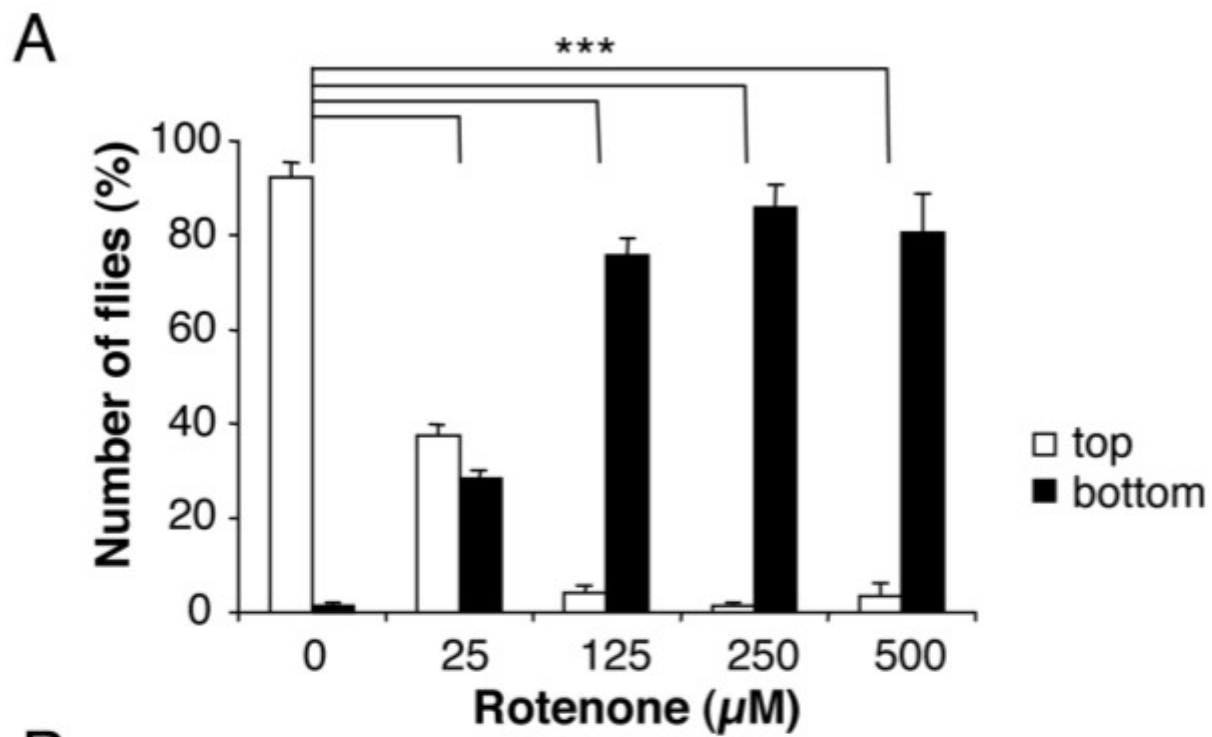

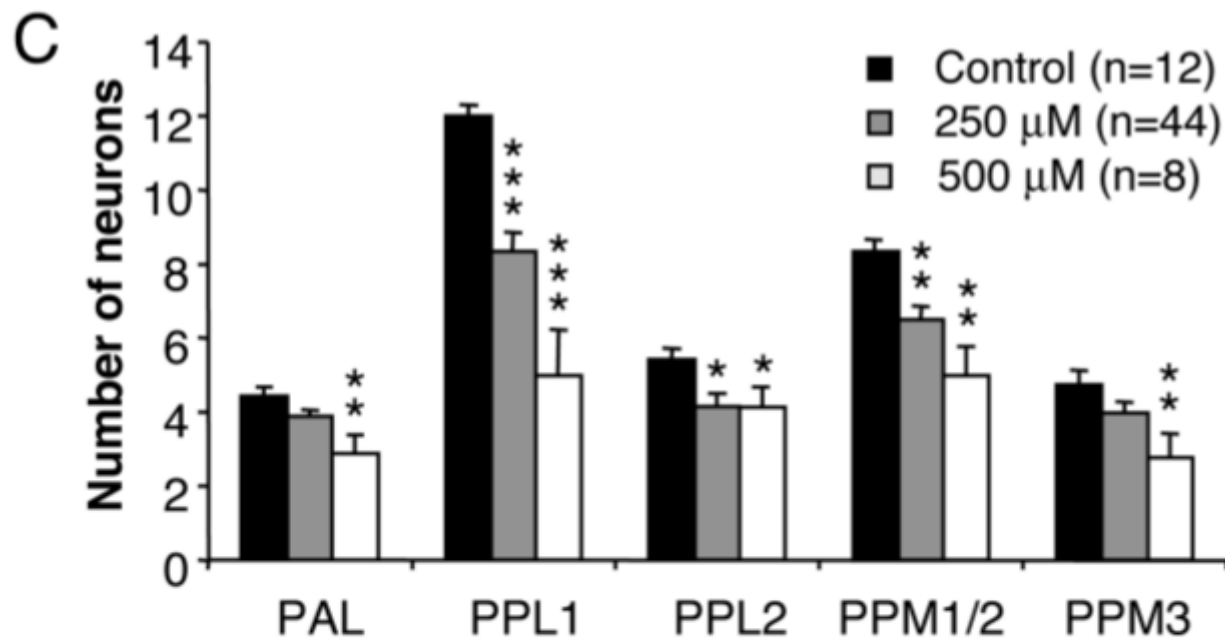
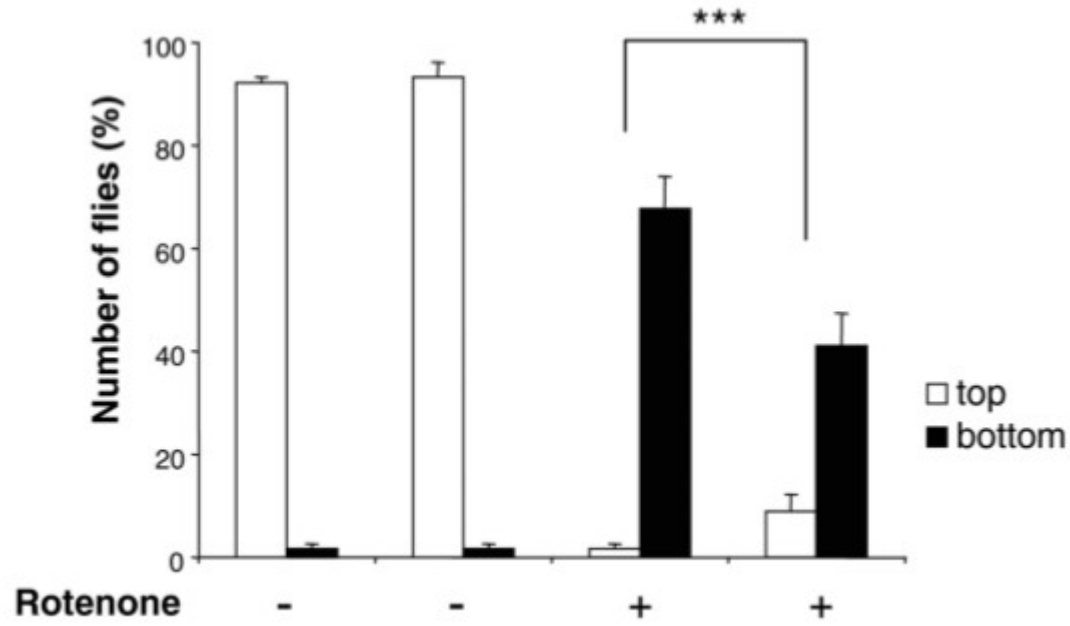
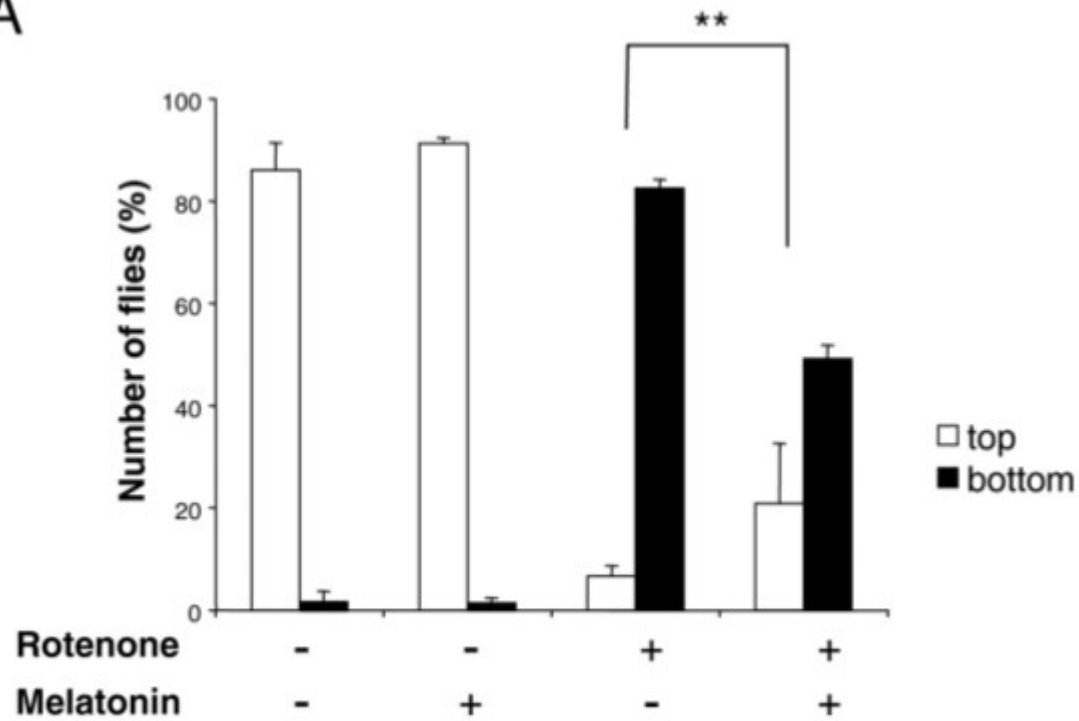

Figure 1. Exposure of *Drosophila* to rotenone induces severe locomotor deficits and dopaminergic neuron loss. *A*, Negative geotaxis assay of adult flies exposed previously for 7 d to various amounts of rotenone. White bars indicate the percentage of flies that climbed to the top of the column, and black bars indicate the percentage of flies that remained at the bottom after 1 min. Differences in PI between control and rotenone-treated flies were highly significant ($***p < 0.001$). *B1*, Schematic representation of the dopaminergic neuron clusters in *Drosophila* adult brain in frontal view. *B2–B4*, Tyrosine hydroxylase immunolabeling showing dopaminergic neuron patterns in multifocal confocal views of adult fly brains after 7 d of exposure to 0 (control), 250, and 500 μ M rotenone, respectively. White arrows indicate the total absence of certain clusters after rotenone exposure (PPM3 in *B3* and PAM and PAL in *B4*). Scale bars, 50 μ m. *C*, Quantification of the number of neurons in dopaminergic clusters of control brains (black bars) or in brains of flies exposed for 7 d to 250 μ M (gray bars) or 500 μ M (white bars) rotenone. The density of the neurons in the PAM clusters was too high to allow precise scoring of their number. *n* indicates the number of brain hemispheres examined in each condition. * $p < 0.05$, ** $p < 0.01$, and *** $p < 0.001$ compared with control values.

A**A**

- From drugs to phenotypes through genes (*target screen*)

Fragile X syndrome (FXS) is a genetic syndrome that is the most commonly known single-gene cause of autism and the most common inherited cause of intellectual disability.

It results in a spectrum of characteristic physical and intellectual limitations and emotional and behavioral features which range from severe to mild in manifestation.

The syndrome is associated with the expansion of a single trinucleotide gene sequence (CGG) on the X-chromosome, and results in a failure to express the protein coded by the *FMR1* gene, which is required for normal neural development.

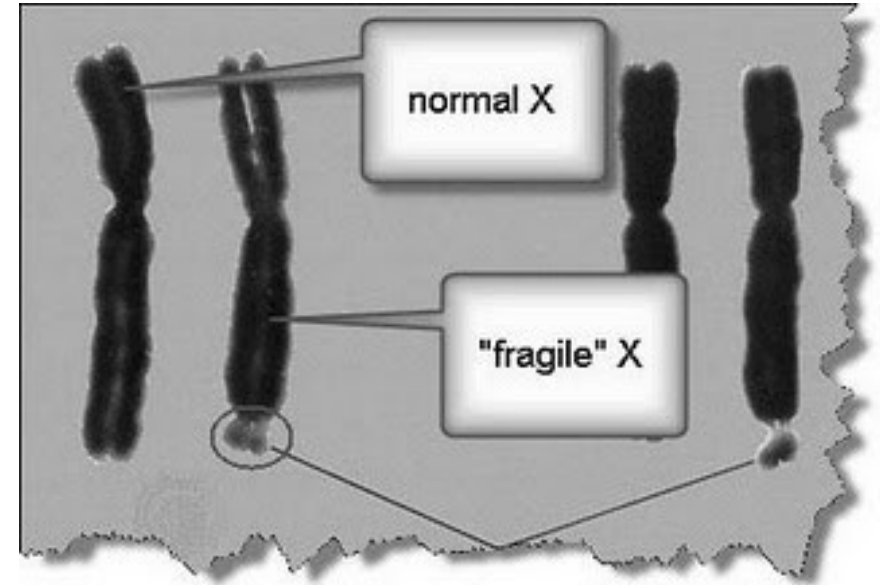

Identify candidate genes based on phenotype through **forward genetics** screening
e.g.: drop-dead, bubblegum, swisscheese

Gene is recessive
(LOF)

Gene is dominant
(GOF)

Disrupt the function of endogenous genes via mutations, RNAi or knock-ins

Overexpress the mutated or wild type version; often it's OK to overexpress the mammalian homolog

Perform pharmacological screenings or genetic suppressor screening to find new candidates

A. Nervous System

1. Neurodegeneration.
2. Alzheimer's Disease.
3. Parkinson's Disease.
4. Triplet Repeat Expansion Diseases.
5. Sleep.
6. Seizure Disorders.
7. Cognitive/Psychosis/Affective Disorders.

B. Cancer

C. Cardiovascular

D. Inflammation/Infectious Disease

E. Metabolic Disorders and Diabetes

TABLE 3
Neurotransmitter-related behaviors

NT/Receptor	CNS-Related Behavior	Reference
Serotonin	Feeding, aggression, courtship, sleep, learning and memory	Dierick and Greenspan, 2007; Sitaraman et al., 2008; Alekseyenko et al., 2010; Neckameyer, 2010
5-HT _{1A-like}	Aggression, sleep, learning and memory	Yuan et al., 2005; Johnson et al., 2008, 2009
5-HT ₂	Circadian, aggression, visual processing	Nichols and Sanders-Bush, 2002; Nichols, 2007; Johnson et al., 2008
5-HT ₇	Learning and memory, courtship and mating	Johnson et al. 2010; C. D. Nichols, unpublished data
Dopamine	Locomotor activity, arousal, circadian	Foltenyi et al., 2007; Hirsh et al., 2010
D1	Learning and memory, prepulse inhibition	Lebestky et al., 2009; Waddell, 2010
D2	Locomotor activity, arousal	Draper et al., 2007
Glutamate	Social interaction, learning and memory	Grosjean et al., 2008
GABA	Sleep, circadian, learning and memory	Chung et al., 2009; Hamasaka et al., 2005; Davis, 2005
Acetylcholine	Learning and memory, circadian	Gu and O'Dowd, 2006; Hamasaka et al., 2007

TABLE 2
Genetic models of neurodegeneration

Diseases/Gene	Invertebrate or Animal	Phenotypes	References
Alzheimer's Disease β -Amyloid protein	<i>C. elegans</i>	Progressive paralysis, cytoplasmic protein accumulation, fibrillar amyloid formation	Link, 1995; Fay et al., 1998; Drake et al., 2003; Wu et al., 2006; Hornsten et al., 2007; Hassan et al., 2009
	<i>D. melanogaster</i>	Eye degeneration, Accumulation of amyloid plaques, reduced life span, locomotor defect, and vacuolation of the brain	Finelli et al., 2004; Crowther et al., 2005; Luheshi et al., 2007
	Zebrafish	Reduced body length, short and curly tail, defective convergent-extension movements in embryos	Joshi et al., 2009
Presenilin	<i>C. elegans</i>	Defects in neurite morphology, temperature memory, egg laying	Wittenburg et al., 2000
	<i>D. melanogaster</i>	Pupal lethality, dorsoscutellar bristle duplications, wing notching and wing vein defects	Seidner et al., 2006
	Zebrafish	Decreased cell proliferation and de novo neurogenesis, Irregular delineation of somites	Nornes et al., 2003; Van Tijn et al., 2009
Tau	<i>C. elegans</i>	Age-dependent progressive neurodegeneration, accumulation of insoluble tau; reduced lifespan, age-dependent progressive impairment in touch response, embryonic lethality and mechanosensory defect	Kraemer et al., 2003; Miyasaka et al., 2005; Gordon et al., 2008; Feuillette et al., 2010
	<i>D. melanogaster</i>	Eye degeneration, disruption of the microtubular network at presynaptic nerve terminals, axonal degeneration, neuromuscular junctions morphological defects	Williams et al., 2000; Whittman et al., 2001; Jackson et al., 2002; Mudher et al., 2004; Nishimura et al., 2004; Chee et al., 2005; Blard et al., 2007; Chen et al., 2007
	Zebrafish	Pathological hyperphosphorylation, conformational changes, and tau aggregation	Paquet et al., 2009
Parkinson's Disease α -Synuclein	<i>C. elegans</i>	Mitochondrial stress, dopaminergic degeneration, developmental defect, upregulation of dopamine synthesis, redistribution of dopaminergic synaptic vesicles	Lakso et al., 2003; Springer et al., 2005; Ved et al., 2005; Kuwahara et al., 2006; Karpinar et al., 2009; Hamamichi et al., 2008; Kuwahara et al., 2008; van Ham et al., 2008; Settivari et al., 2009; Cao et al., 2010
	<i>D. melanogaster</i>	Age+ dependent loss of dopaminergic neuron and progressive climbing defect	Feany and Bender, 2000; Auluck and Bonini, 2002; Auluck et al., 2002; Coulom and Birman, 2004; Pesah et al., 2005
	Zebrafish	Zebrafish homologs of human α -synuclein are known but no animal model published yet	Sun and Gitler, 2008; Chen et al., 2009
Parkin and Pink	<i>C. elegans</i>	Hypersensitivity toward proteotoxic stress conditions, Parkin insolubility and aggregation	Springer et al., 2005
	<i>D. melanogaster</i>	Dopaminergic neuron loss, age-dependent motor deficits, reduced lifespan, locomotor defects, male sterility and mitochondrial pathology	Greene et al., 2003; Haywood and Staveley, 2004; Pesah et al., 2004; Cha et al., 2005; Sang et al., 2007
	Zebrafish	Dopaminergic neuron loss, reduced mitochondrial respiratory chain complex I activity, severe developmental defect	Anichtchik et al., 2008; Flinn et al., 2009; Xi et al., 2010

developmental defects

Triplet repeat expansion diseases			
Huntington's disease	<i>C. elegans</i>	Huntingtin-positive cytoplasmic aggregates, sensory process degeneration, axonal swelling, mechanosensory defects and perinuclear huntingtin aggregates	Faber et al., 1999; Parker et al., 2001, 2005; Brignull et al., 2006
	<i>D. melanogaster</i>	Axonal transport defect, lethality, neurodegeneration, behavioral and electrophysiological defects	Gunawardena et al., 2003; Romero et al., 2008
Spinal and bulbar muscular atrophy	Zebrafish	Massive neuronal apoptosis, small eyes and heads and enlargement of brain ventricle, lower jaw abnormalities; defect in iron utilization and development	Lumsden et al., 2007; Henshall et al., 2009
	<i>C. elegans</i>	None	Takeyama et al., 2002; Pandey et al., 2007a,b; Nedelsky et al., 2010
	<i>D. melanogaster</i>	Accumulation of expanded polyglutamine containing androgen receptor, protein aggregation, eye degeneration, locomotor defect	
Fragile X syndrome	Zebrafish	None	
	<i>C. elegans</i>	None	
	<i>D. melanogaster</i>	Eye degeneration, age-related cognitive impairment, abnormal circadian rhythms, courtship behavior defect, lethality, defect in synaptogenesis, spermatogenesis	Wan et al., 2000; Zhang et al., 2001; Dockendorff et al., 2002; Morales et al., 2002; Jin et al., 2007; Sekine et al., 2008; Sofola et al., 2008; Choi et al., 2010
	Zebrafish	Abnormal axonal branching, cardiomyopathy, muscular dystrophy	Tucker et al., 2006; Van't Padje et al., 2009

Table 1. Rescue of phenotypes of *Drosophila* and mouse FXS models

Analysis	Phenotype	Rescuing treatments	Reference(s)
<i>Drosophila</i>			
Neuronal anatomy	Mushroom-body crossover defect	Lithium*, MPEP*, MPPG*, MTPG* and LY341495*	McBride et al., 2005
		GABA [†] , creatinine [†] and nipecotic acid [†]	Chang et al., 2008
	Over-elaboration of NMJ structure	Pilocarpine nitrate [‡] and aminobenzotropine [‡]	Chang et al., 2008
	Elevated presynaptic vesicle pool	MPEP* and genetic reduction of DmGluRA	Pan et al., 2008
		MPEP* and genetic reduction of DmGluRA	Pan et al., 2008
Behavior	Naive-courtship defect	Lithium*, MPEP*, MPPG*, MTPG* and LY341495*	McBride et al., 2005
		GABA [†] , creatinine [†] and nipecotic acid [†]	Chang et al., 2008
		Pilocarpine nitrate [‡] and aminobenzotropine ^{‡,¶}	Chang et al., 2008
Cognition	Immediate-recall memory deficit	Lithium*, MPEP*, MPPG*, MTPG* and LY341495*	McBride et al., 2005
	Short-term memory deficit	Lithium*, MPEP*, MPPG*, MTPG* and LY341495*	McBride et al., 2005
	Long-term memory deficit	MPEP*	Bolduc et al., 2008**
	Earlier age of onset of loss of learning	Lithium*, MPEP*, MPPG*, MTPG* and LY341495*	McBride et al., 2005
Mouse			
Neuronal anatomy	Increased dendritic-spine density	Genetic reduction of mGluR5, MPEP*, fenobam*	Dolen et al., 2007; de Vrij et al., 2008
Behavior	Longer duration at center of open field	MPEP*, dnPAK	Yan et al., 2005; Hayashi et al., 2007
	Audiogenic seizures	MPEP*, dnPAK	Yan et al., 2005; Hayashi et al., 2007
		Genetic reduction of mGluR5	Dolen et al., 2007
		Baclofen [§]	Pacey et al., 2009
Prepulse inhibition of startle	MPEP*	de Vrij et al., 2008	
Cognition/neuronal plasticity	Exaggerated extinction of inhibitory avoidance	Genetic reduction of mGluR5	Dolen et al., 2007
	Impaired trace fear conditioning	dnPAK	Hayashi et al., 2007
	Increased ocular-dominance plasticity	Genetic reduction of mGluR5	Dolen et al., 2007
	Acquisition of passive-avoidance task	Taurine [¶]	El Idrissi et al., 2009
Physiology	Reduced cortical LTP	dnPAK	Hayashi et al., 2007
Biochemistry	Increased basal protein synthesis	Genetic reduction of mGluR5	Dolen et al., 2007

